

CS145: INTRODUCTION TO DATA MINING

1: Introduction

Instructor: Yizhou Sun

yzsun@cs.ucla.edu

October 1, 2018

Course Information

- Course homepage:
http://web.cs.ucla.edu/~yzsun/classes/2018Fall_CS145/index.html
- Class Schedule
 - Slides
 - Announcement
 - Assignments
 - ...

- Prerequisites

- You are expected to have background knowledge in data structures, algorithms, basic linear algebra, and basic statistics.
- You will also need to be familiar with at least one programming language, and have programming experiences.

Meeting Time and Location

- When
 - M&W, 12:00pm-1:50pm
- Where
 - Franz Hall Room 1260

Instructor and TA Information

- Instructor: Yizhou Sun
 - Homepage: <http://web.cs.ucla.edu/~yzsun/>
 - Email: yzsun@cs.ucla.edu
 - Office: 3531E
 - Office hour: Wednesdays 3-5pm

- TAs:

- Yunsheng Bai (yba@cs.ucla.edu)

- office hours: 3:00-5:00pm Thursdays @BH 3256S

- Junheng Hao (haojh.ucla@gmail.com)

- office hours: 3:00-5:00pm Tuesdays @BH 3256S

- Shengming Zhang (michaelzhang@cs.ucla.edu)

- office hours: 3:00-5:00pm Mondays @BH 3256S

Grading

- Homework: 25%
- Midterm exam: 25%
- Final exam: 20%
- Course project: 25%
- Participation: 5%

Grading: Homework

- Homework: 25%
 - 4 assignments are expected
 - Deadline: 11:59pm of the indicated due date via *ccl*e system
 - *Late submission policy*: get original score* $\mathbf{1}(t \leq 24)e^{-(\ln(2)/12)*t}$ if you are t hours late.
- **No copying or sharing of homework!**
 - But you can discuss general challenges and ideas with others
 - *Suspicious cases will be reported to The Office of the Dean of Students*

Grading: Midterm and Final Exams

- Midterm exam: 25%
- Final exam: 20%
 - Closed book exams, but you can take a “reference sheet” of A4 size

Grading: Course Project

- Course project: 25%
 - Group project (4-5 people for one group)
 - Goal: Solve a given data mining problem
 - Choose among several tasks
 - Crawl data + mine data + present results
 - You are expected to submit a project report and your code at the end of the quarter

Grading: Participation

- Participation (5%)
 - In-class participation
 - Quizzes
 - Online participation (piazza)
 - <https://piazza.com/ucla/fall2018/cs145/home>

Textbook

- Recommended: Jiawei Han, Micheline Kamber, and Jian Pei. [Data Mining: Concepts and Techniques](#), 3rd edition, Morgan Kaufmann, 2011
- References
 - "Data Mining: The Textbook" by Charu Aggarwal (<http://www.charuaggarwal.net/Data-Mining.htm>)
 - "Data Mining" by Pang-Ning Tan, Michael Steinbach, and Vipin Kumar (<http://www-users.cs.umn.edu/~kumar/dmbook/index.php>)
 - "Machine Learning" by Tom Mitchell (<http://www.cs.cmu.edu/~tom/mlbook.html>)
 - "Introduction to Machine Learning" by Ethem ALPAYDIN (<http://www.cmpe.boun.edu.tr/~ethem/i2ml/>)
 - "Pattern Classification" by Richard O. Duda, Peter E. Hart, David G. Stork (<http://www.wiley.com/WileyCDA/WileyTitle/productCd-0471056693.html>)
 - "The Elements of Statistical Learning: Data Mining, Inference, and Prediction" by Trevor Hastie, Robert Tibshirani, and Jerome Friedman (<http://www-stat.stanford.edu/~tibs/ElemStatLearn/>)
 - "Pattern Recognition and Machine Learning" by Christopher M. Bishop (<http://research.microsoft.com/en-us/um/people/cmbishop/prml/>)

Goals of the Course

- Know what data mining is and learn the basic algorithms
- Know how to apply algorithms to real-world applications
- Provide a starting course for research in data mining

1. Introduction

- Why Data Mining? 
- What Is Data Mining?
- A Multi-Dimensional View of Data Mining
 - What Kinds of Data Can Be Mined?
 - What Kinds of Patterns Can Be Mined?
 - What Kinds of Technologies Are Used?
 - What Kinds of Applications Are Targeted?
- Content covered by this course

Why Data Mining?

- The Explosive Growth of Data: from terabytes to petabytes
 - Data collection and data availability
 - Automated data collection tools, database systems, Web, computerized society
 - Major sources of abundant data
 - Business: Web, e-commerce, transactions, stocks, ...
 - Science: Remote sensing, bioinformatics, scientific simulation, ...
 - Society and everyone: news, digital cameras, YouTube, social media, mobile devices, ...
- We are drowning in data, but starving for knowledge!
- “Necessity is the mother of invention”—Data mining—Automated analysis of massive data sets

1. Introduction

- Why Data Mining?
- What Is Data Mining? 
- A Multi-Dimensional View of Data Mining
 - What Kinds of Data Can Be Mined?
 - What Kinds of Patterns Can Be Mined?
 - What Kinds of Technologies Are Used?
 - What Kinds of Applications Are Targeted?
- Content covered by this course

What Is Data Mining?



- Data mining (knowledge discovery from data)
 - Extraction of interesting (non-trivial, implicit, previously unknown and potentially useful) patterns or knowledge from huge amount of data
- Alternative names
 - Knowledge discovery (mining) in databases (KDD), knowledge extraction, data/pattern analysis, data archeology, data dredging, information harvesting, business intelligence, etc.

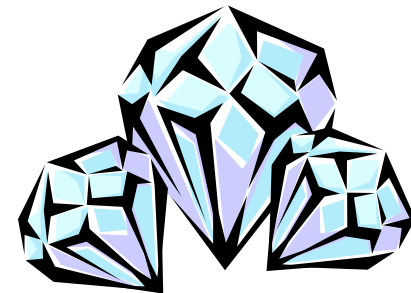

Knowledge Discovery (KDD) Process

- This is a view from typical database systems and data warehousing communities
- Data mining plays an essential role in the knowledge discovery process

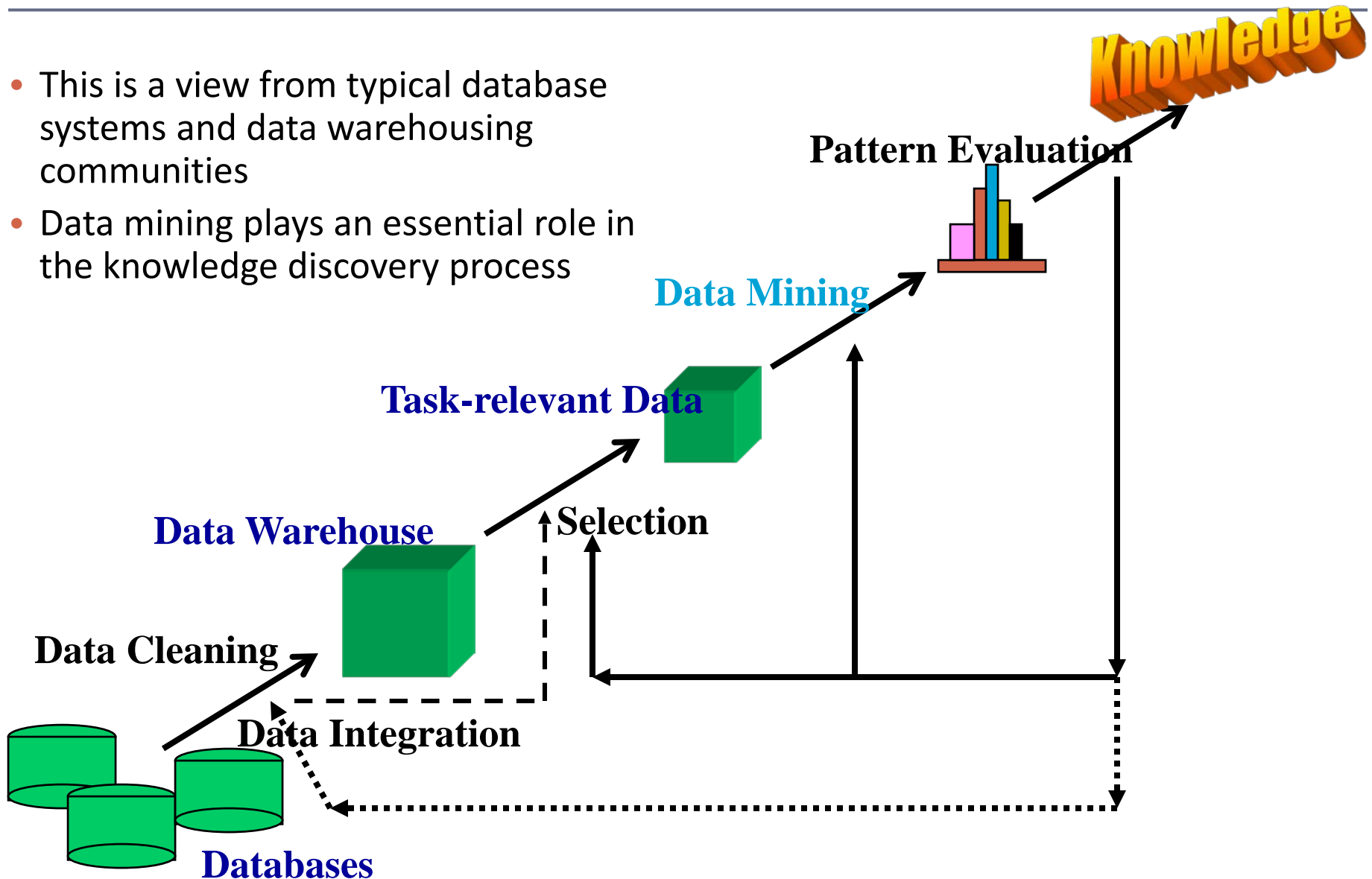

Data Mining in Business Intelligence

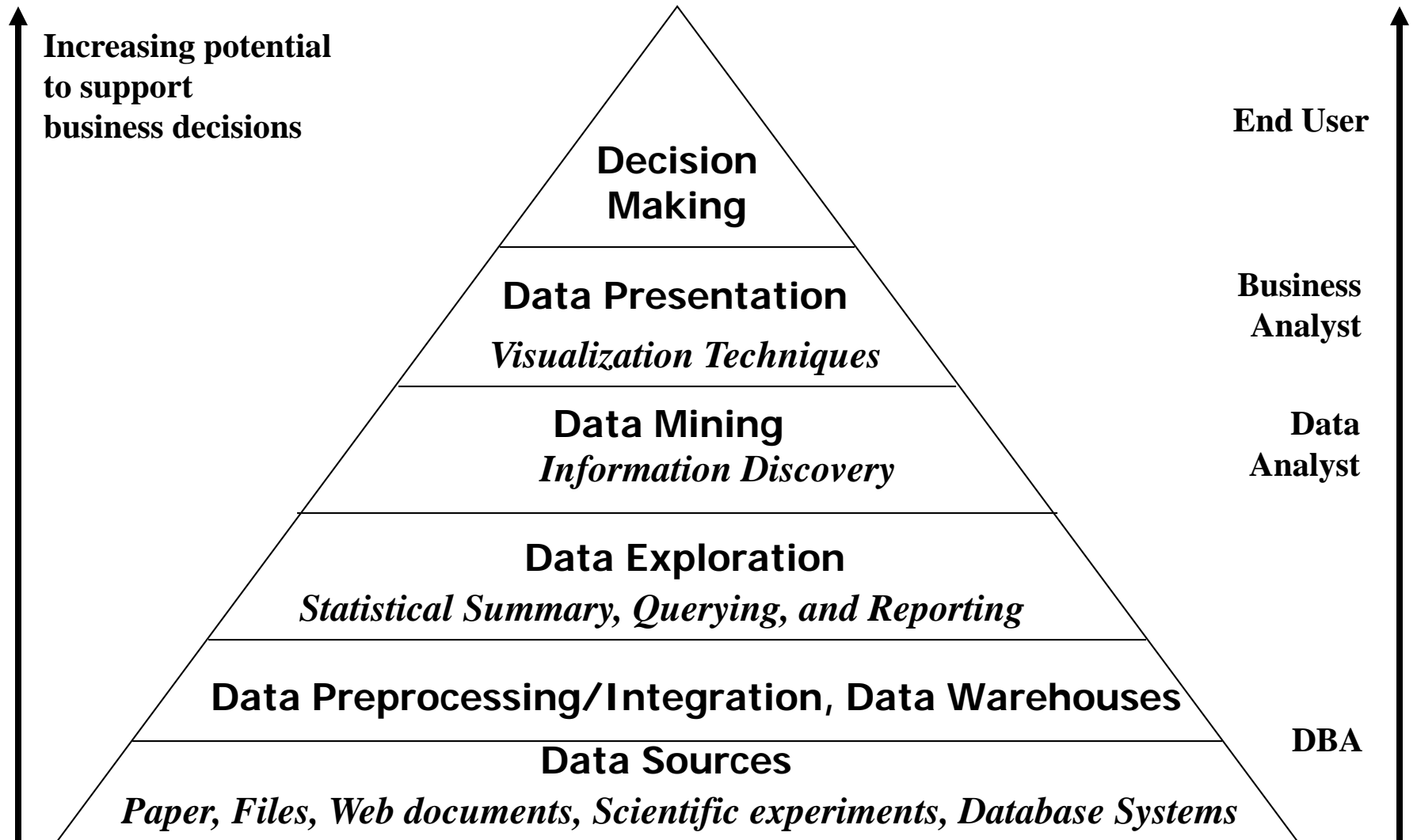

KDD Process: A Typical View from ML and Statistics

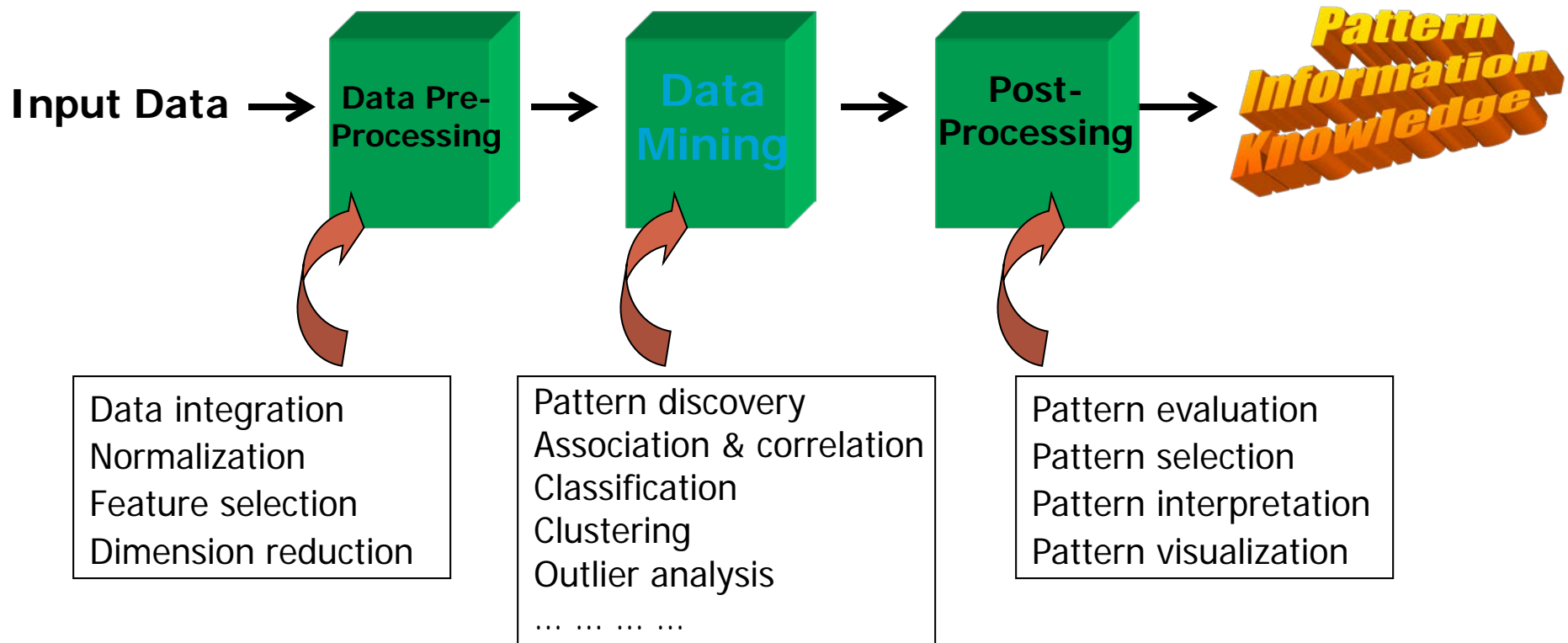

- This is a view from typical machine learning and statistics communities

1. Introduction

- Why Data Mining?
- What Is Data Mining?
- A Multi-Dimensional View of Data Mining 
 - What Kinds of Data Can Be Mined?
 - What Kinds of Patterns Can Be Mined?
 - What Kinds of Technologies Are Used?
 - What Kinds of Applications Are Targeted?
- Content covered by this course

Multi-Dimensional View of Data Mining

- **Data to be mined**
 - Database data (extended-relational, object-oriented, heterogeneous, legacy), data warehouse, transactional data, stream, spatiotemporal, time-series, sequence, text and web, multi-media, graphs & social and information networks
- **Knowledge to be mined (or: Data mining functions)**
 - Characterization, discrimination, association, classification, clustering, trend/deviation, outlier analysis, etc.
 - Descriptive vs. predictive data mining
 - Multiple/integrated functions and mining at multiple levels
- **Techniques utilized**
 - Data-intensive, data warehouse (OLAP), machine learning, statistics, pattern recognition, visualization, high-performance, etc.
- **Applications adapted**
 - Retail, telecommunication, banking, fraud analysis, bio-data mining, stock market analysis, text mining, Web mining, etc.

1. Introduction

- Why Data Mining?
- What Is Data Mining?
- A Multi-Dimensional View of Data Mining
 - What Kinds of Data Can Be Mined? 
 - What Kinds of Patterns Can Be Mined?
 - What Kinds of Technologies Are Used?
 - What Kinds of Applications Are Targeted?
- Content covered by this course

Vector Data

	Sex	Race	Height	Income	Marital Status	Years of Educ.	Liberalness
R1001	M	1	70	50	1	12	1.73
R1002	M	2	72	100	2	20	4.53
R1003	F	1	55	250	1	16	2.99
R1004	M	2	65	20	2	16	1.13
R1005	F	1	60	10	3	12	3.81
R1006	M	1	68	30	1	9	4.76
R1007	F	5	66	25	2	21	2.01
R1008	F	4	61	43	1	18	1.27
R1009	M	1	69	67	1	12	3.25

Set Data

<i>TID</i>	<i>Items</i>
1	Bread, Coke, Milk
2	Beer, Bread
3	Beer, Coke, Diaper, Milk
4	Beer, Bread, Diaper, Milk
5	Coke, Diaper, Milk

Text Data

- “Text mining, also referred to as text data mining, roughly equivalent to text analytics, refers to the process of deriving high-quality information from text. High-quality information is typically derived through the devising of patterns and trends through means such as statistical pattern learning. Text mining usually involves the process of structuring the input text (usually parsing, along with the addition of some derived linguistic features and the removal of others, and subsequent insertion into a database), deriving patterns within the structured data, and finally evaluation and interpretation of the output. 'High quality' in text mining usually refers to some combination of relevance, novelty, and interestingness. Typical text mining tasks include text categorization, text clustering, concept/entity extraction, production of granular taxonomies, sentiment analysis, document summarization, and entity relation modeling (i.e., learning relations between named entities).” –from wiki

Text Data – Topic Modeling

Topics

gene 0.04
dna 0.02
genetic 0.01
...

life 0.02
evolve 0.01
organism 0.01
...

brain 0.04
neuron 0.02
nerve 0.01
...

data 0.02
number 0.02
computer 0.01
...

Documents

Seeking Life's Bare (Genetic) Necessities

COLD SPRING HARBOR, NEW YORK— How many **genes** does an **organism** need to **survive**? Last week at the genome meeting here,* two genome researchers with radically different approaches presented complementary views of the basic genes needed for **life**. One research team, using **computer** analyses to compare known **genomes**, concluded that today's **organisms** can be sustained with just 250 genes, and that the earliest life forms required a mere 128 **genes**. The other researcher mapped genes in a simple parasite and estimated that for this organism, 800 genes are plenty to do the job—but that anything short of 100 wouldn't be enough.

Although the numbers don't match precisely, those **predictions**

"are not all that far apart," especially in comparison to the 75,000 **genes** in the human genome, notes Siv Andersson at Uppsala University in Sweden. "They arrived at the 800 number. But coming up with a consensus answer may be more than just a **genetic** numbers game, particularly as more and more **genomes** are completely mapped and sequenced. "It may be a way of organizing any newly **sequenced genome**," explains Arcady Mushegian, a **computational** molecular biologist at the National Center for Biotechnology Information (NCBI) in Bethesda, Maryland. Comparing an



* Genome Mapping and Sequencing, Cold Spring Harbor, New York, May 8 to 12.

Stripping down. Computer analysis yields an estimate of the minimum modern and ancient genomes.

SCIENCE • VOL. 272 • 24 MAY 1996

Topic proportions and assignments

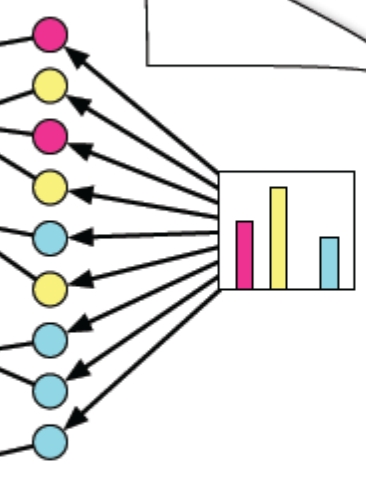

Text Data – Word Embedding

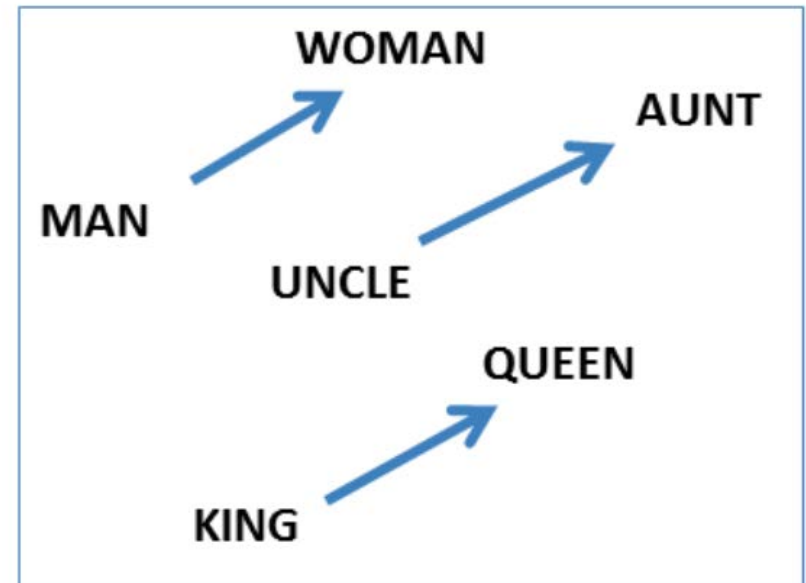
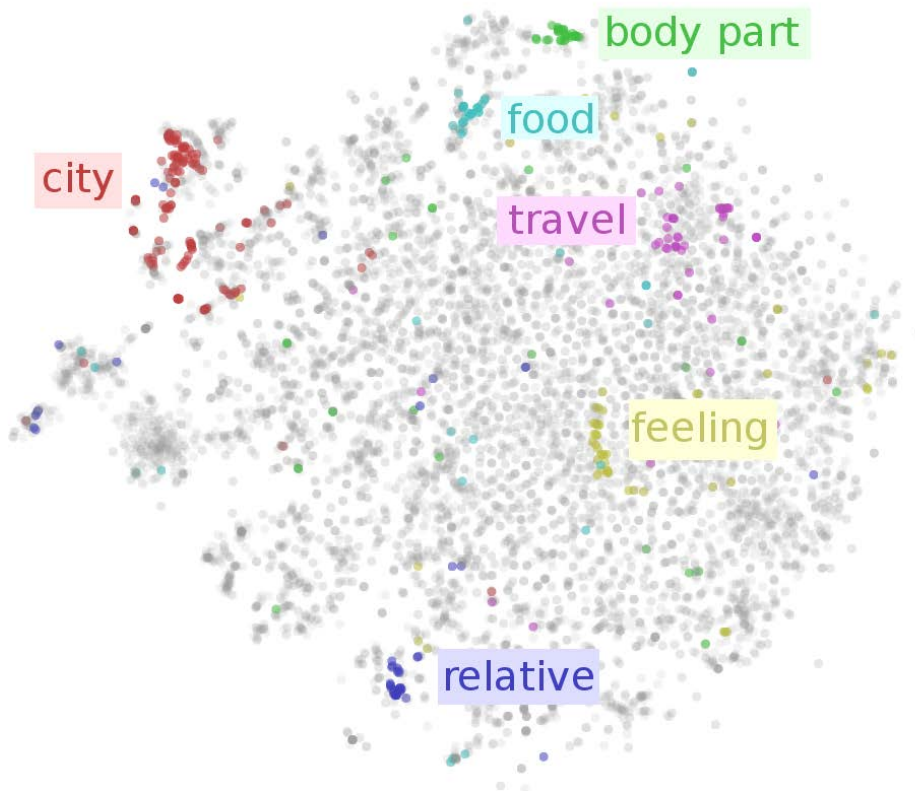

king - man + woman = queen

Sequence Data

SYNTENIC ASSEMBLIES FOR CG15386

MD106 ATGCTTAGTAATCCCTACTTTAAGTCCGTTTTGTGGCTGATTGGCTTCGGAGGAATGGG
NEWC ATGCTTAGTAATCCCTACTTTAATCCGTTTTGTGGCTGATTGGCTTCGGAGGAATGGG
W501 ATGCTTAGTAATCCCTACTTTAAGTCCGTTTTGTGGCTGATTGGCTTCGGAGGAATGGG
MD199 ATGCTTAGTAATCCCTACTTTAAGTCCGTTTTGTGGCTGATTGGCTTCGGAGGAATGGG
C1674 ATGCTTAGTAATCCCTACTTTAAGTCCGTTTTGTGGCTGATTGGCTTCGGAGGAATGGG
SIM4 ATGCTTAGTAATCCCTACTTTAAGTCCGTTTTGTGGCTGATTGGCTTCGGAGGAATGGG

MD106 CTACGGCCTAATGGTGCTAACAGAGCCGAACGTCGACAAAATAGAGCGCATCAAAGCCT
NEWC CTACGGCCTAATGGTGCTAACCGAGCCGAACGTCGACAAAATAGAGCGCATCAAAGCCT
W501 CTACGGCCTAATGGTGCTAACCGAGCCGAACGTCGACAAAATAGAGCGCATCAAAGCCT
MD199 CTACGGCCTAATGGTGCTAACCGAGCCGAACGTCGACAAAATAGAGCGCATCAAAGCCT
C1674 CTACGGCCTAATGGTGCTAACCGAGCCGAACGTCGACAAAATAGAGCGCATCAAAGCCT
SIM4 CTACGGCCTAATGGTGCTAACCGAGCCGAACGTCGACAAAATAGAGCGCATCAAAGCCT

MD106 CCGTTTCAAGTACCAAACCTGAGTGCGGATGAGCAGCGAAAGGCTCTGTTTATGAAGAAG
NEWC CCGTTTCAAGTACCAAACCTGAGTGCGGATGAGCAGCGAAAGGCTCTGTTTATGAAGAAG
W501 CCGTTTCAAGTACCAAACCTGAGTGCGGATGAGCAGCGAAAGGCTCTGTTTATGAAGAAG
MD199 CCGTTTCAAGTACCAAACCTGAGTGCGGATGAGCAGCGAAAGGCTCTGTTTATGAAGAAG
C1674 CCGTTTCAAGTACCAAACCTGAGTGCGGATGAGCAGCGAAAGGCTCTGTTTATGAAGAAG
SIM4 CCGTTTCAAGTACCAAACCTGAGTGCGGATGAGCAGCGAAAGGCTCTGTTTATGAAGAAG

MD106 CTGCAGGAGGCGTCCACCACCAAGTGCCCCAATCTACAGGTCAGCGGCCGAGAAATAG
NEWC CTGCAGGAGGCGTCCACCACCAAGTGCCCCAATCTACAGGTCATCGGCCGAGAAATAG
W501 CTGCAGGAGGCGTCCACCACCACTGCCCCAATCTACAGGTCATCGGCCGAGAAATAG
MD199 CTGCAGGAGGCGTCCACCACCAAGTGCCCCAATCTACAGGTCAGCGGCCGAGAAATAG
C1674 CTGCAGGAGGCGTCCACCACCAAGTGCCCCAATCTACAGGTCAGCGGCCGAGAAATAG
SIM4 CTGCAGGAGGCGTCCACCACCAAGTGCCCCAATCTACAGGTCAGCGGCCGAGAAATAG

Sequence Data – Seq2Seq

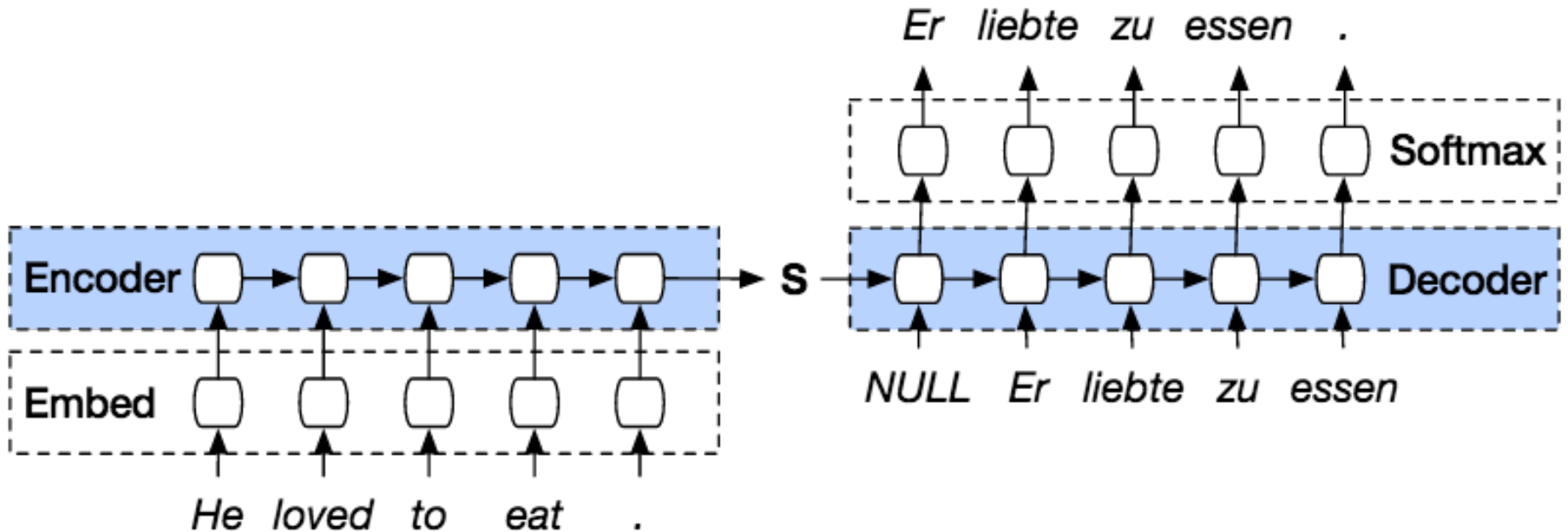

Time Series

Weekly U.S. Retail Gasoline Prices, Regular Grade

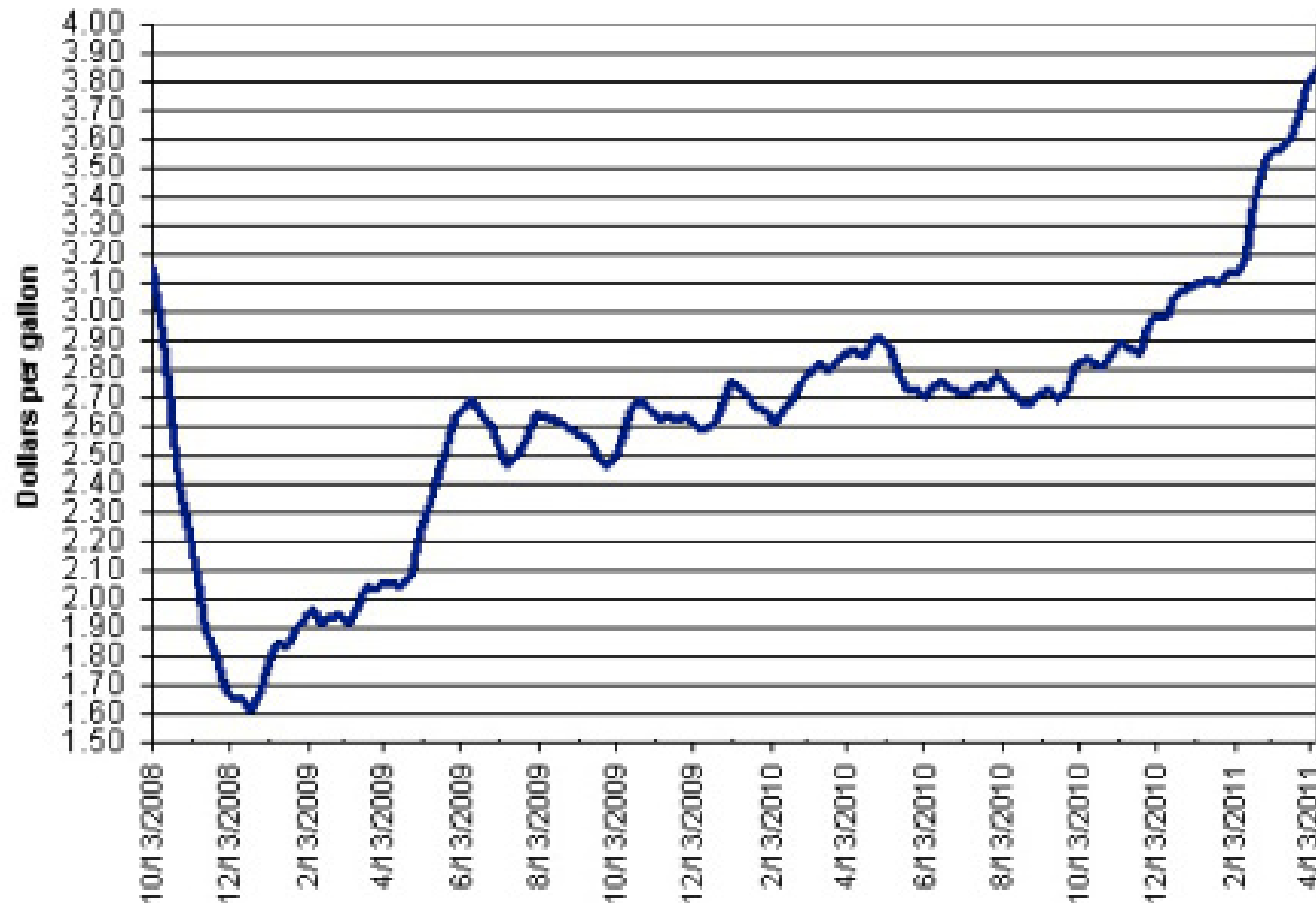

Source: Energy Information Administration

Graph / Network

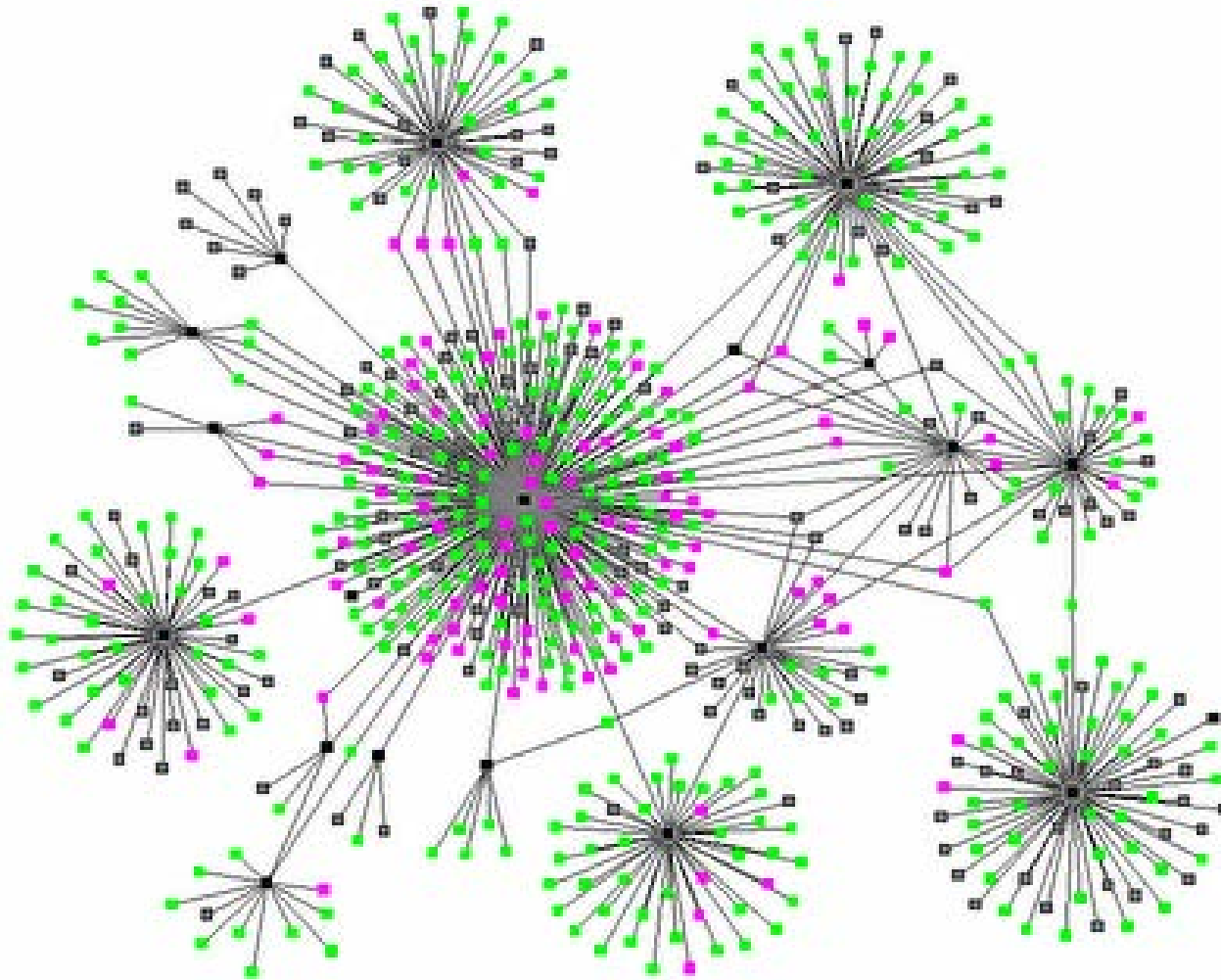

Graph / Network

– Community Detection

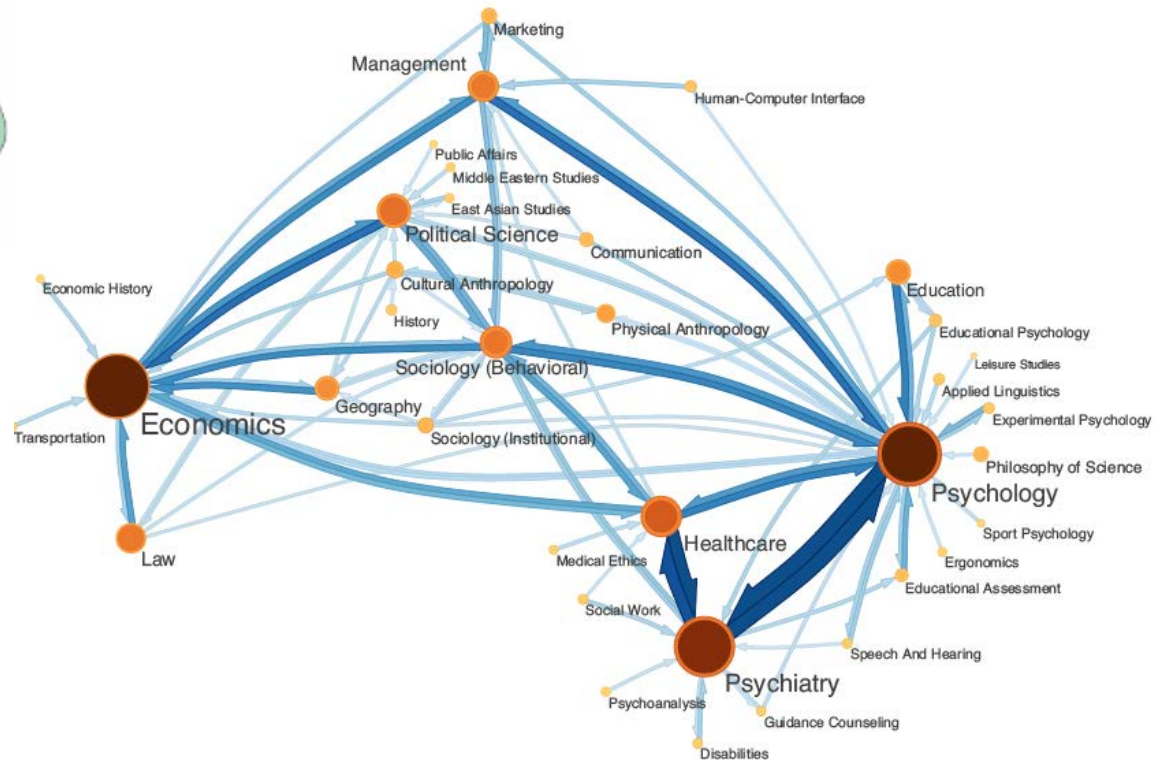
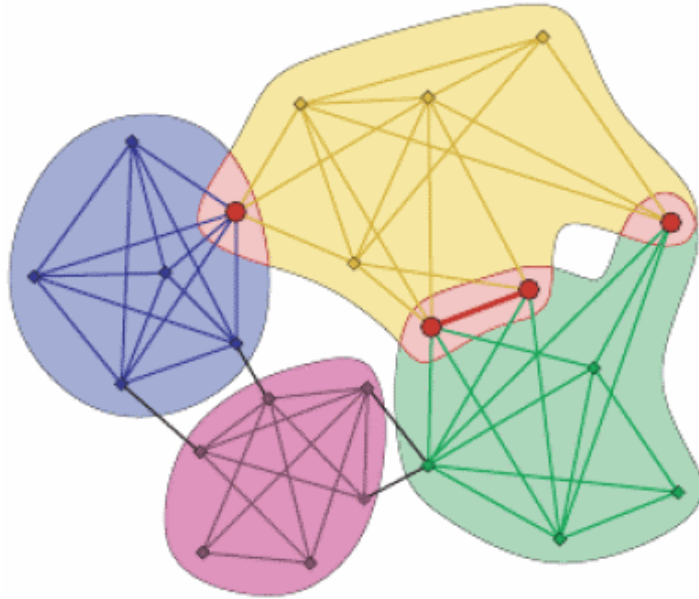

Image Data



Image Data – Neural Style Transfer

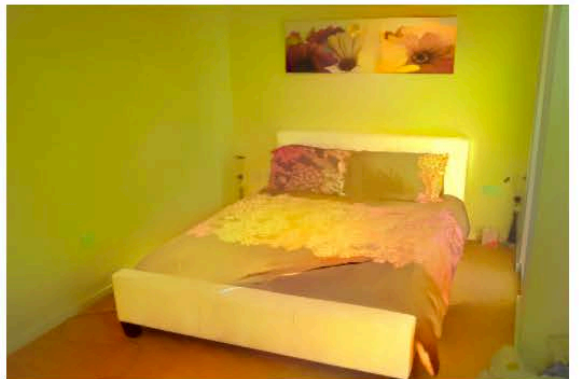
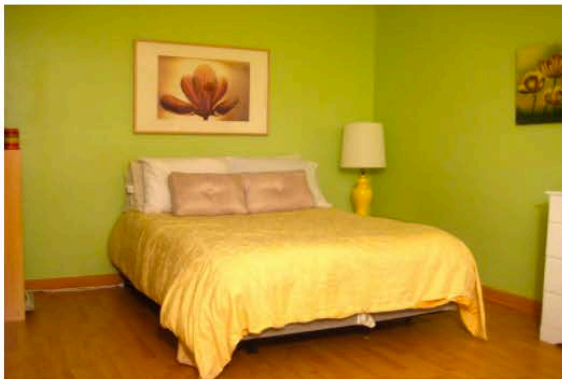
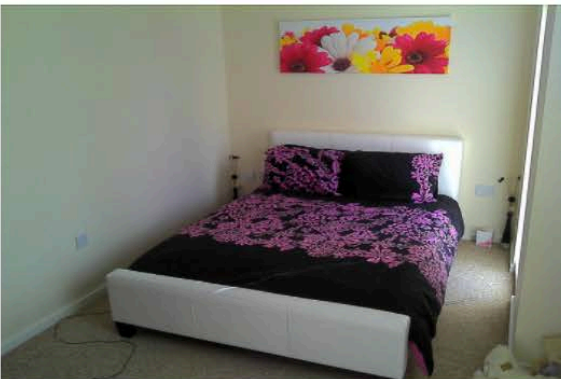
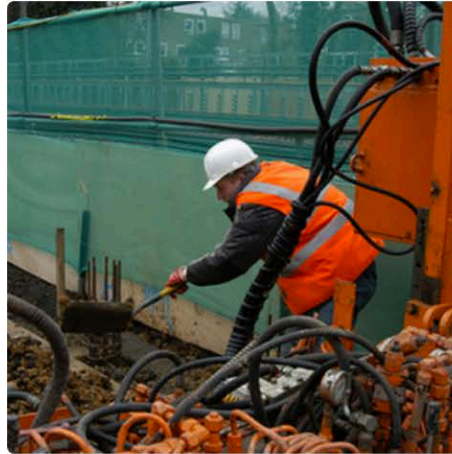

Image Data – Image Captioning



"man in black shirt is playing guitar."



"construction worker in orange safety vest is working on road."



"two young girls are playing with lego toy."

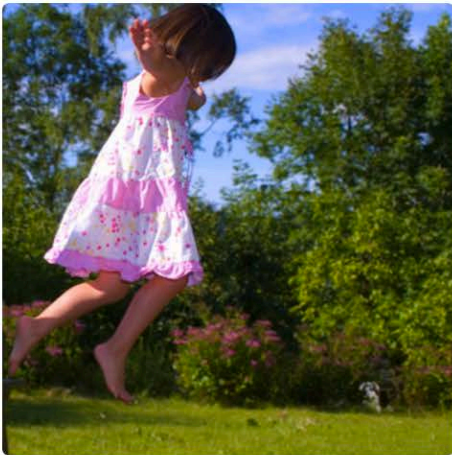

"girl in pink dress is jumping in air."

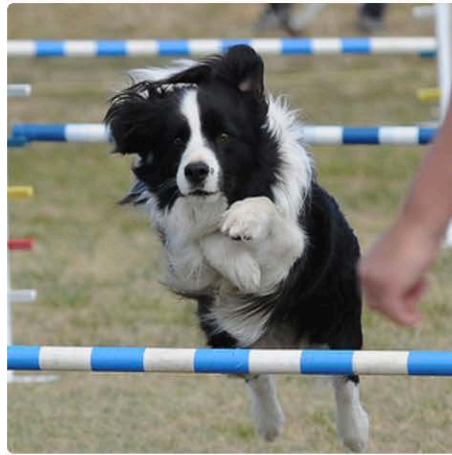

"black and white dog jumps over bar."



"young girl in pink shirt is swinging on swing."

1. Introduction

- Why Data Mining?
- What Is Data Mining?
- A Multi-Dimensional View of Data Mining
 - What Kinds of Data Can Be Mined?
 - What Kinds of Patterns Can Be Mined? 
 - What Kinds of Technologies Are Used?
 - What Kinds of Applications Are Targeted?
- Content covered by this course

Data Mining Function: Association and Correlation Analysis

- Frequent patterns (or frequent itemsets)
 - What items are frequently purchased together in your Amazon transactions?
- Association, correlation vs. causality
 - A typical association rule
 - Diaper \rightarrow Beer [0.5%, 75%] (support, confidence)

Data Mining Function: Classification

- Classification and label prediction
 - Construct models (functions) based on some training examples
 - Describe and distinguish classes or concepts for future prediction
 - E.g., classify countries based on (climate), or classify cars based on (gas mileage)
 - Predict some unknown class labels
- Typical methods
 - Decision trees, naïve Bayesian classification, support vector machines, neural networks, rule-based classification, pattern-based classification, logistic regression, ...
- Typical applications:
 - Credit card fraud detection, direct marketing, classifying stars, diseases, web-pages, ...

Image Classification Example



Data Mining Function: Cluster Analysis

- Unsupervised learning (i.e., Class label is unknown)
- Group data to form new categories (i.e., clusters), e.g., cluster houses to find distribution patterns
- Principle: Maximizing intra-class similarity & minimizing interclass similarity
- Many methods and applications

Clustering Example

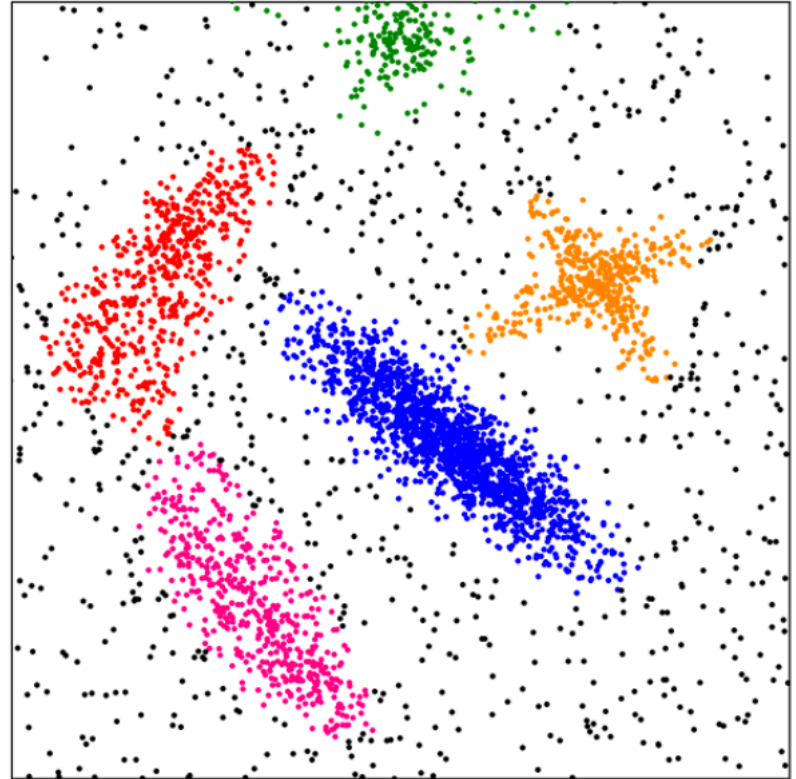
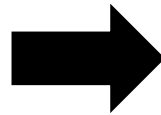
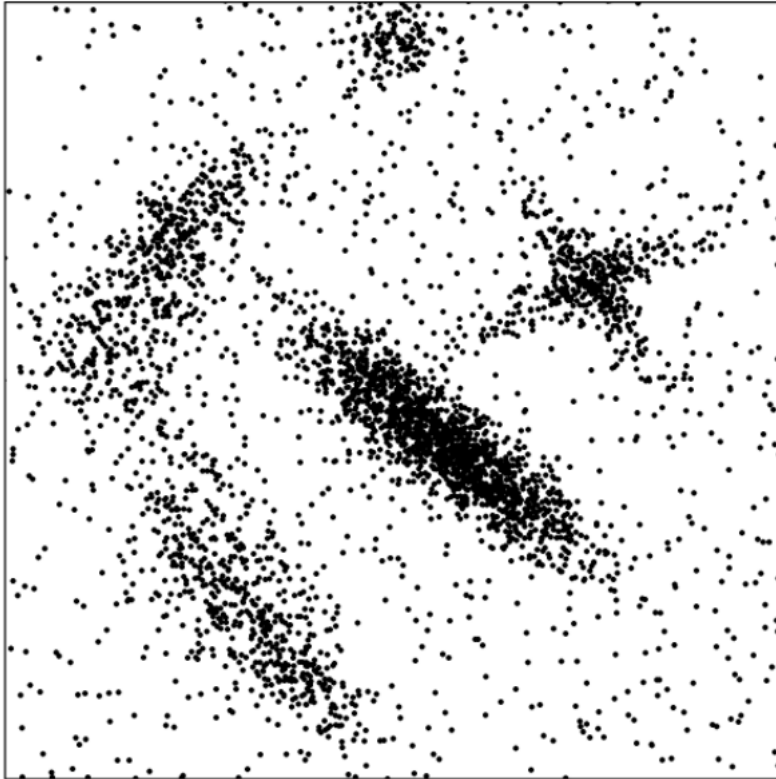

Data Mining Functions: Others

- Prediction
- Similarity search
- Ranking
- Outlier detection
- ...

1. Introduction

- Why Data Mining?
- What Is Data Mining?
- A Multi-Dimensional View of Data Mining
 - What Kinds of Data Can Be Mined?
 - What Kinds of Patterns Can Be Mined?
 - What Kinds of Technologies Are Used? 
 - What Kinds of Applications Are Targeted?
- Content covered by this course

Data Mining: Confluence of Multiple Disciplines

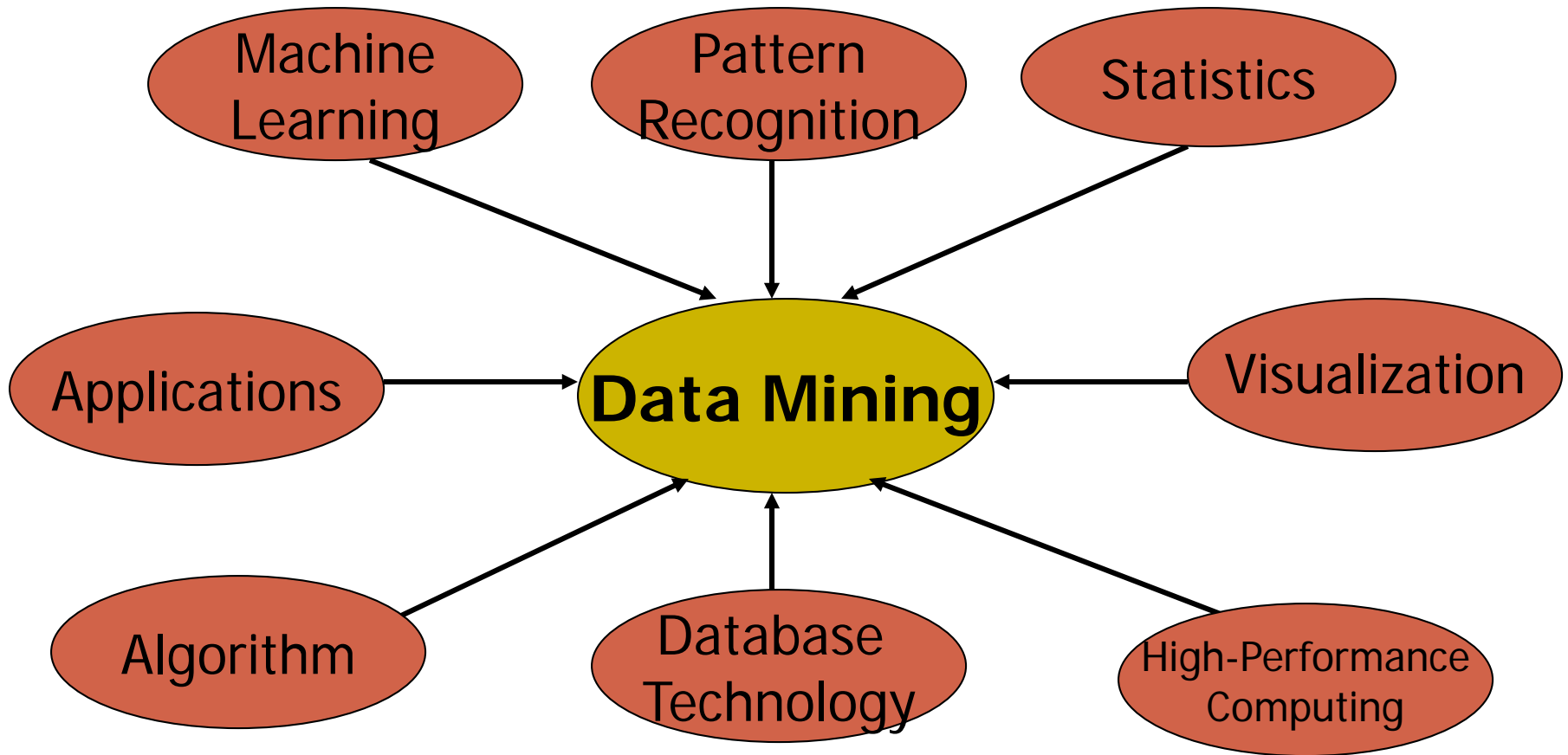

1. Introduction

- Why Data Mining?
- What Is Data Mining?
- A Multi-Dimensional View of Data Mining
 - What Kinds of Data Can Be Mined?
 - What Kinds of Patterns Can Be Mined?
 - What Kinds of Technologies Are Used?
 - What Kinds of Applications Are Targeted? 
- Content covered by this course

Applications of Data Mining

- Web page analysis: from web page classification, clustering to PageRank & HITS algorithms
- Collaborative analysis & recommender systems
- Basket data analysis to targeted marketing
- Biological and medical data analysis: classification, cluster analysis (microarray data analysis), biological sequence analysis, biological network analysis
- Data mining and software engineering (e.g., IEEE Computer, Aug. 2009 issue)
- Social media
- Game

Google Flu Trends

- <https://www.youtube.com/watch?v=6111nS66Dpk>

Annual U.S. Flu Activity - Mid-Atlantic Region

ILI percentage

● Google Flu Trends ● CDC Data

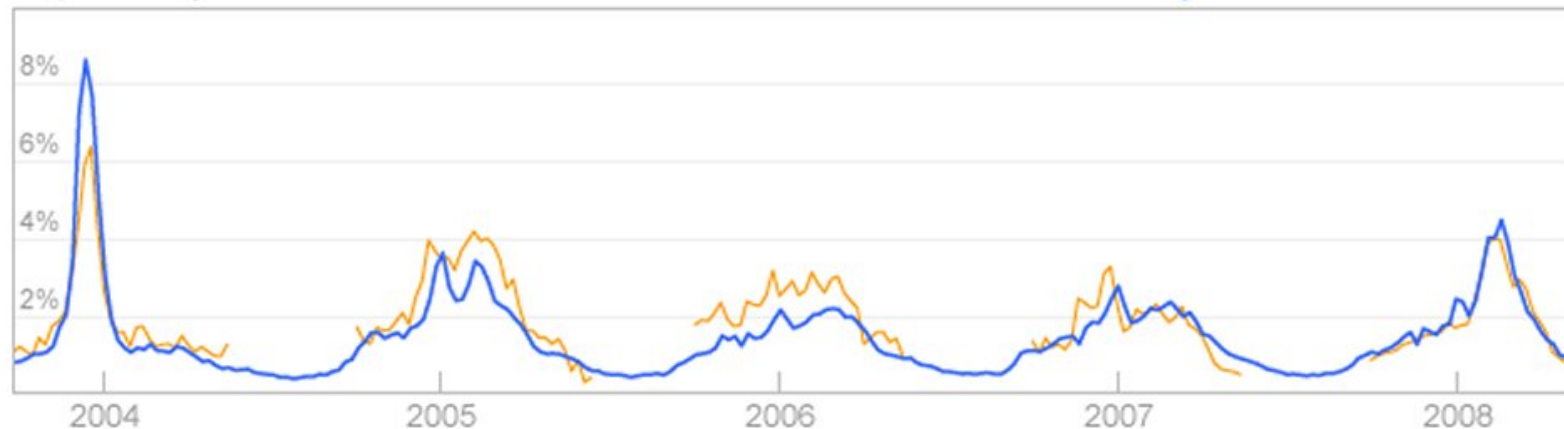

NetFlix Prize

- https://www.youtube.com/watch?v=4_e2sNYYfxA

NETFLIX

Netflix Prize

COMPLETED

Home Rules Leaderboard Update

Leaderboard

Showing Test Score. [Click here to show quiz score](#)

Display top leaders.

Rank	Team Name	Best Test Score	% Improvement	Best Submit Time
Grand Prize - RMSE = 0.8567 - Winning Team: BellKor's Pragmatic Chaos				
1	BellKor's Pragmatic Chaos	0.8567	10.06	2009-07-26 18:18:28
2	The Ensemble	0.8567	10.06	2009-07-26 18:38:22
3	Grand Prize Team	0.8582	9.90	2009-07-10 21:24:40
4	Opera Solutions and Vandelay United	0.8588	9.84	2009-07-10 01:12:31
5	Vandelay Industries !	0.8591	9.81	2009-07-10 00:32:20
6	PragmaticTheory	0.8594	9.77	2009-06-24 12:06:56
7	BellKor in BigChaos	0.8601	9.70	2009-05-13 08:14:09
8	Dace	0.8612	9.59	2009-07-24 17:18:43
9	Feeds2	0.8622	9.48	2009-07-12 13:11:51
10	BigChaos	0.8623	9.47	2009-04-07 12:33:59
11	Opera Solutions	0.8623	9.47	2009-07-24 00:34:07
12	BellKor	0.8624	9.46	2009-07-26 17:19:11

Facebook MyPersonality App

- <https://www.youtube.com/watch?v=GOZArvMMHKs>

Private traits and attributes are predictable from digital records of human behavior

Michal Kosinski^{a,1}, David Stillwell^a, and Thore Graepel^b

^aFree School Lane, The Psychometrics Centre, University of Cambridge, Cambridge CB2 3RQ United Kingdom; and ^bMicrosoft Research, Cambridge CB1 2FB, United Kingdom

Edited by Kenneth Wachter, University of California, Berkeley, CA, and approved February 12, 2013 (received for review October 29, 2012)

We show that easily accessible digital records of behavior, Facebook Likes, can be used to automatically and accurately predict a range of highly sensitive personal attributes including: sexual orientation, ethnicity, religious and political views, personality traits, intelligence, happiness, use of addictive substances, parental separation, age, and gender. The analysis presented is based on a dataset of over 58,000 volunteers who provided their Facebook Likes, detailed demographic profiles, and the results of several psychometric tests. The proposed model uses dimensionality reduction for preprocessing the Likes data, which are then entered into logistic/linear regression to predict individual psychodemographic profiles from Likes. The model correctly discriminates between homosexual and heterosexual men in 88% of cases, African Americans and Caucasian Americans in 95% of cases, and between Democrat and Republican in 85% of cases. For the personality trait "Openness," prediction accuracy is close to the test-retest accuracy of a standard personality test. We give examples of associations between attributes and Likes and discuss implications for online personalization

browsing logs (11–15). Similarly, it has been shown that personality can be predicted based on the contents of personal Web sites (16), music collections (17), properties of Facebook or Twitter profiles such as the number of friends or the density of friendship networks (18–21), or language used by their users (22). Furthermore, location within a friendship network at Facebook was shown to be predictive of sexual orientation (23).

This study demonstrates the degree to which relatively basic digital records of human behavior can be used to automatically and accurately estimate a wide range of personal attributes that people would typically assume to be private. The study is based on Facebook Likes, a mechanism used by Facebook users to express their positive association with (or "Like") online content, such as photos, friends' status updates, Facebook pages of products, sports, musicians, books, restaurants, or popular Web sites. Likes represent a very generic class of digital records, similar to Web search queries, Web browsing histories, and credit card purchases. For example, observing users' Likes related to music

1. Introduction

- Why Data Mining?
- What Is Data Mining?
- A Multi-Dimensional View of Data Mining
 - What Kinds of Data Can Be Mined?
 - What Kinds of Patterns Can Be Mined?
 - What Kinds of Technologies Are Used?
 - What Kinds of Applications Are Targeted?
- Content covered by this course 

Course Content

- Functions to be covered
 - Prediction and classification
 - Clustering
 - Frequent pattern mining and association rules
 - Similarity search
- Data types to be covered
 - Vector data
 - Set data
 - Sequential data
 - Text data

Methods to Learn

	Vector Data	Set Data	Sequence Data	Text Data
Classification	Logistic Regression; Decision Tree; KNN SVM; NN			Naïve Bayes for Text
Clustering	K-means; hierarchical clustering; DBSCAN; Mixture Models			PLSA
Prediction	Linear Regression GLM			
Frequent Pattern Mining		Apriori; FP growth	GSP; PrefixSpan	
Similarity Search			DTW	

Where to Find References? DBLP, CiteSeer, Google

- Data mining and KDD (SIGKDD: CDROM)
 - Conferences: ACM-SIGKDD, IEEE-ICDM, SIAM-DM, PKDD, PAKDD, etc.
 - Journal: Data Mining and Knowledge Discovery, KDD Explorations, ACM TKDD
- Database systems (SIGMOD: ACM SIGMOD Anthology—CD ROM)
 - Conferences: ACM-SIGMOD, ACM-PODS, VLDB, IEEE-ICDE, EDBT, ICDT, DASFAA
 - Journals: IEEE-TKDE, ACM-TODS/TOIS, JIIS, J. ACM, VLDB J., Info. Sys., etc.
- AI & Machine Learning
 - Conferences: ICML, AAI, IJCAI, COLT (Learning Theory), CVPR, NIPS, etc.
 - Journals: Machine Learning, Artificial Intelligence, Knowledge and Information Systems, IEEE-PAMI, etc.
- Web and IR
 - Conferences: SIGIR, WWW, WSDM, CIKM, etc.
 - Journals: WWW: Internet and Web Information Systems,
- Statistics
 - Conferences: Joint Stat. Meeting, etc.
 - Journals: Annals of statistics, etc.
- Visualization
 - Conference proceedings: CHI, ACM-SIGGraph, etc.
 - Journals: IEEE Trans. visualization and computer graphics, etc.

Recommended Reference Books

- **E. Alpaydin. Introduction to Machine Learning, 2nd ed., MIT Press, 2011**
- **S. Chakrabarti. Mining the Web: Statistical Analysis of Hypertext and Semi-Structured Data. Morgan Kaufmann, 2002**
- **R. O. Duda, P. E. Hart, and D. G. Stork, Pattern Classification, 2ed., Wiley-Interscience, 2000**
- **T. Dasu and T. Johnson. Exploratory Data Mining and Data Cleaning. John Wiley & Sons, 2003**
- **U. M. Fayyad, G. Piatetsky-Shapiro, P. Smyth, and R. Uthurusamy. Advances in Knowledge Discovery and Data Mining. AAAI/MIT Press, 1996**
- **U. Fayyad, G. Grinstein, and A. Wierse, Information Visualization in Data Mining and Knowledge Discovery, Morgan Kaufmann, 2001**
- **J. Han, M. Kamber, and J. Pei, Data Mining: Concepts and Techniques. Morgan Kaufmann, 3rd ed. , 2011**
- **T. Hastie, R. Tibshirani, and J. Friedman, The Elements of Statistical Learning: Data Mining, Inference, and Prediction, 2nd ed., Springer, 2009**
- **B. Liu, Web Data Mining, Springer 2006**
- **T. M. Mitchell, Machine Learning, McGraw Hill, 1997**
- **Y. Sun and J. Han, Mining Heterogeneous Information Networks, Morgan & Claypool, 2012**
- **P.-N. Tan, M. Steinbach and V. Kumar, Introduction to Data Mining, Wiley, 2005**
- **S. M. Weiss and N. Indurkha, Predictive Data Mining, Morgan Kaufmann, 1998**
- **I. H. Witten and E. Frank, Data Mining: Practical Machine Learning Tools and Techniques with Java Implementations, Morgan Kaufmann, 2nd ed. 2005**

Major Concepts Related to Probability and Statistics

- Elements of Probability
 - Sample space, event space, probability measure
 - Conditional probability
 - Independence, conditional independence
- Random variables
 - Cumulative distribution function, Probability mass function (for discrete random variable), Probability density function (for continuous random variable)
 - Expectation, variance
 - Some frequently used distributions
 - Discrete: Bernoulli, binomial, geometric, poisson
 - Continuous: uniform, exponential, normal
- More random variables
 - Joint distribution, marginal distribution, joint and marginal probability mass function, joint and marginal density function
 - Chain rule
 - Bayes' rule
 - Independence
 - Expectation, conditional expectation, and covariance

Major Concepts in Linear Algebra

- Vectors
 - Addition, scalar multiplication, norm, dot product (inner product), projection, cosine similarity
- Matrices
 - Addition, scalar multiplication, matrix-matrix multiplication, trace, eigenvalues and eigenvectors

Optimization Related

- MLE and MAP Principle
- Gradient descent / stochastic gradient descent
- Newton's method
- Expectation-Maximum algorithm (EM)

About PTE

- For graduate students:
 - **CS247: Advanced Data Mining**
 - Focus on Text, Recommender Systems, and Networks/Graphs
 - Will be offered in Spring 2019
 - **CS249: Probabilistic Models for Structured Data**
 - Focus on Probabilistic Models on text and graph data
 - Will be offered in Winter 2019