

Exercise 14.6 (Figure 14.35)

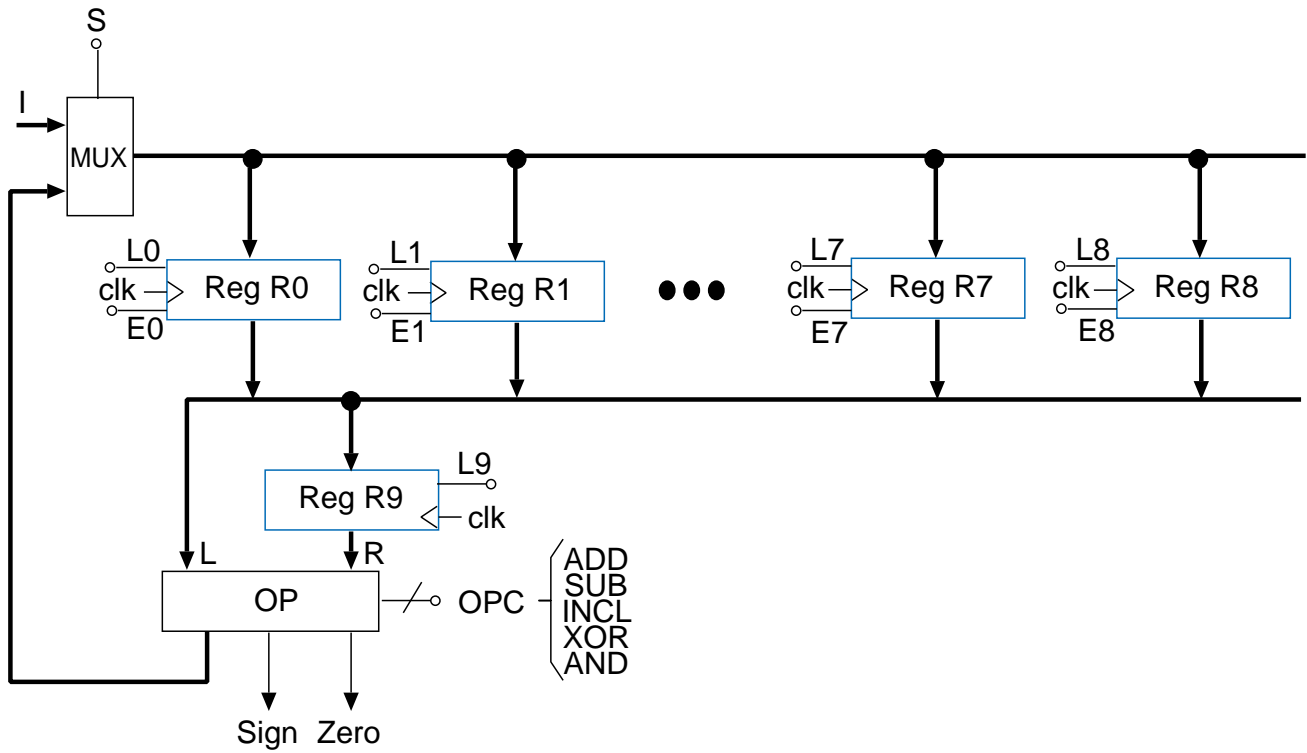

Exercise 14.11 (Figure 14.36)