

CS249: ADVANCED DATA MINING

Text Data: Topic Models

Instructor: Yizhou Sun

yzsun@cs.ucla.edu

April 25, 2019

Methods to Learn

	Vector Data	Text Data	Graph & Network	Recommender Systems
Classification	Regression; NN		Label Propagation	
Clustering	K-means; kernel k-means; Mixture Models	PLSA; LDA	Spectral Clustering	Matrix Factorization
Prediction	NN			Collaborative Filtering; Factorization machine; Hybrid CF; Recommendation with graph regularization
Ranking			PageRank	
Similarity Search			P-PageRank	
Representation Learning		Word embedding	Network embedding	Deep collaborative learning

Text Data: Topic Models

- Text Data and Topic Models 
- Revisit of Multinomial Mixture Model
- Probabilistic Latent Semantic Analysis (pLSA)
- Latent Dirichlet Allocation (LDA)
- Summary

Text Data

- Word/term
- Document
 - A sequence of words
- Corpus
 - A collection of documents



Represent a Document

- Most common way: Bag-of-Words
 - Ignore the order of words
 - keep the count

c1: *Human machine interface* for Lab ABC *computer* applications
c2: A *survey* of *user* opinion of *computer system response time*
c3: The *EPS user interface* management *system*
c4: *System* and *human system* engineering testing of *EPS*
c5: Relation of *user-perceived response time* to error measurement

m1: The generation of random, binary, unordered *trees*
m2: The intersection *graph* of paths in *trees*
m3: *Graph minors* IV: Widths of *trees* and well-quasi-ordering
m4: *Graph minors*: A *survey*



	c1	c2	c3	c4	c5	m1	m2	m3	m4
<i>human</i>	1	0	0	1	0	0	0	0	0
<i>interface</i>	1	0	1	0	0	0	0	0	0
<i>computer</i>	1	1	0	0	0	0	0	0	0
<i>user</i>	0	1	1	0	1	0	0	0	0
<i>system</i>	0	1	1	2	0	0	0	0	0
<i>response</i>	0	1	0	0	1	0	0	0	0
<i>time</i>	0	1	0	0	1	0	0	0	0
<i>EPS</i>	0	0	1	1	0	0	0	0	0
<i>survey</i>	0	1	0	0	0	0	0	0	1
<i>trees</i>	0	0	0	0	0	1	1	1	0
<i>graph</i>	0	0	0	0	0	0	1	1	1
<i>minors</i>	0	0	0	0	0	0	0	1	1

Vector space model

More Details

- Represent the doc as a vector where each entry corresponds to a different word and the number at that entry corresponds to how many times that word was present in the document (or some function of it)
 - Number of words is huge
 - Select and use a smaller set of words that are of interest
 - E.g. uninteresting words: 'and', 'the', 'at', 'is', etc. These are called stop-words
 - Stemming: remove endings. E.g. 'learn', 'learning', 'learnable', 'learned' could be substituted by the single stem 'learn'
 - Other simplifications can also be invented and used
 - The set of different remaining words is called dictionary or vocabulary. Fix an ordering of the terms in the dictionary so that you can operate them by their index.
 - Can be extended to bi-gram, tri-gram, or so

Limitations of Vector Space Model

- Dimensionality
 - High dimensionality
- Sparseness
 - Most of the entries are zero
- Shallow representation
 - The vector representation does not capture semantic relations between words

Topic Models

- Topic modeling
 - Get topics automatically from a corpus
 - Assign documents to topics automatically
- Most frequently used topic models
 - pLSA
 - LDA

“Arts”	“Budgets”	“Children”	“Education”
NEW	MILLION	CHILDREN	SCHOOL
FILM	TAX	WOMEN	STUDENTS
SHOW	PROGRAM	PEOPLE	SCHOOLS
MUSIC	BUDGET	CHILD	EDUCATION
MOVIE	BILLION	YEARS	TEACHERS
PLAY	FEDERAL	FAMILIES	HIGH
MUSICAL	YEAR	WORK	PUBLIC
BEST	SPENDING	PARENTS	TEACHER
ACTOR	NEW	SAYS	BENNETT
FIRST	STATE	FAMILY	MANIGAT
YORK	PLAN	WELFARE	NAMPHY
OPERA	MONEY	MEN	STATE
THEATER	PROGRAMS	PERCENT	PRESIDENT
ACTRESS	GOVERNMENT	CARE	ELEMENTARY
LOVE	CONGRESS	LIFE	HAITI

The William Randolph Hearst Foundation will give \$1.25 million to Lincoln Center, Metropolitan Opera Co., New York Philharmonic and Juilliard School. “Our board felt that we had a real opportunity to make a mark on the future of the performing arts with these grants an act every bit as important as our traditional areas of support in health, medical research, education and the social services,” Hearst Foundation President Randolph A. Hearst said Monday in announcing the grants. Lincoln Center’s share will be \$200,000 for its new building, which will house young artists and provide new public facilities. The Metropolitan Opera Co. and New York Philharmonic will receive \$400,000 each. The Juilliard School, where music and the performing arts are taught, will get \$250,000. The Hearst Foundation, a leading supporter of the Lincoln Center Consolidated Corporate Fund, will make its usual annual \$100,000 donation, too.

Text Data: Topic Models

- Text Data and Topic Models
- Revisit of Multinomial Mixture Model 
- Probabilistic Latent Semantic Analysis (pLSA)
- Latent Dirichlet Allocation (LDA)
- Summary

Review of Multinomial Distribution

- Select n data points from K categories, each with probability p_k



- n trials of independent categorical distribution

- E.g., get 1-6 from a dice with $1/6$

- Let x_k be the number of times value k has been observed, note $\sum_k x_k = n$

- $$P(X_1 = x_1, X_2 = x_2, \dots, X_K = x_K) = \frac{n!}{x_1!x_2!\dots x_K!} \prod_k p_k^{x_k}$$

- When $K=2$, binomial distribution

- n trials of independent Bernoulli distribution

- E.g., flip a coin to get heads or tails



Multinomial Mixture Model

- For documents with bag-of-words representation
 - $\mathbf{x}_d = (x_{d1}, x_{d2}, \dots, x_{dN})$, x_{dn} is the number of words for nth word in the vocabulary
- Generative model
 - For each document
 - Sample its cluster label $z \sim \text{Categorical}(\boldsymbol{\pi})$
 - $\boldsymbol{\pi} = (\pi_1, \pi_2, \dots, \pi_K)$, π_k is the proportion of jth cluster
 - $p(z = k) = \pi_k$
 - Sample its word vector $\mathbf{x}_d \sim \text{multinomial}(\boldsymbol{\beta}_z)$
 - $\boldsymbol{\beta}_z = (\beta_{z1}, \beta_{z2}, \dots, \beta_{zN})$, β_{zn} is the parameter associate with nth word in the vocabulary
 - $p(\mathbf{x}_d | z = k) = \frac{(\sum_n x_{dn})!}{\prod_n x_{dn}!} \prod_n \beta_{kn}^{x_{dn}} \propto \prod_n \beta_{kn}^{x_{dn}}$

Likelihood Function

- For a set of M documents

$$\begin{aligned} L &= \prod_d p(\mathbf{x}_d) = \prod_d \sum_k p(\mathbf{x}_d, z = k) \\ &= \prod_d \sum_k p(\mathbf{x}_d | z = k) p(z = k) \\ &= \prod_d \frac{(\sum_n x_{dn})!}{\prod_n x_{dn}!} \sum_k p(z = k) \prod_n \beta_{kn}^{x_{dn}} \end{aligned}$$

Mixture of Unigrams

- For documents represented by a sequence of words
 - $\mathbf{w}_d = (w_{d1}, w_{d2}, \dots, w_{dN_d})$, N_d is the length of document d , w_{di} is the word at the i th position of the document
- Generative model
 - For each document
 - Sample its cluster label $z \sim \text{Categorical}(\boldsymbol{\pi})$
 - $\boldsymbol{\pi} = (\pi_1, \pi_2, \dots, \pi_K)$, π_k is the proportion of k th cluster
 - $p(z = k) = \pi_k$
 - For each word in the sequence
 - Sample the word $w_{di} \sim \text{Categorical}(\boldsymbol{\beta}_z)$
 - $p(w_{di} | z = k) = \beta_{kw_{di}}$

Likelihood Function

- For a set of M documents

$$\begin{aligned} L &= \prod_d p(\mathbf{w}_d) = \prod_d \sum_k p(\mathbf{w}_d, z = k) \\ &= \prod_d \sum_k p(\mathbf{w}_d | z = k) p(z = k) \\ &= \prod_d \sum_k p(z = k) \prod_i \beta_{kw_{di}} \end{aligned}$$

Question

- Are multinomial mixture model and mixture of unigrams model equivalent?
Why?

Text Data: Topic Models

- Text Data and Topic Models
- Revisit of Multinomial Mixture Model
- Probabilistic Latent Semantic Analysis (pLSA) 
- Latent Dirichlet Allocation (LDA)
- Summary

Notations

- Word, document, topic
 - w, d, z
- Word count in document
 - $c(w, d)$
- Word distribution for each topic (β_z)
 - $\beta_{zw}: p(w|z)$
- Topic distribution for each document (θ_d)
 - $\theta_{dz}: p(z|d)$ (Yes, soft clustering)

Issues of Mixture of Unigrams

- All the words in the same documents are sampled from the same topic

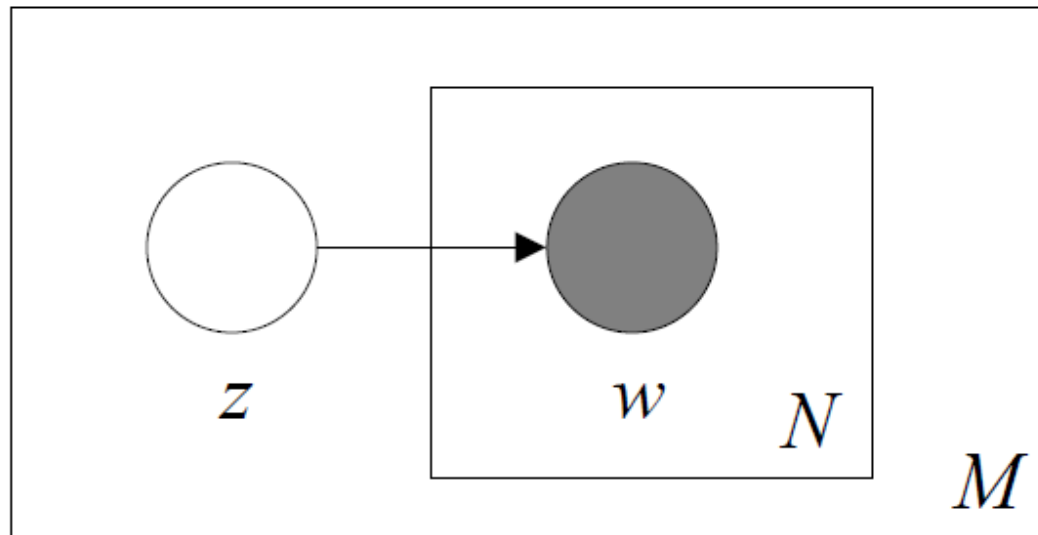

- In practice, people switch topics during their writing

Illustration of pLSA

“Arts”	“Budgets”	“Children”	“Education”
NEW	MILLION	CHILDREN	SCHOOL
FILM	TAX	WOMEN	STUDENTS
SHOW	PROGRAM	PEOPLE	SCHOOLS
MUSIC	BUDGET	CHILD	EDUCATION
MOVIE	BILLION	YEARS	TEACHERS
PLAY	FEDERAL	FAMILIES	HIGH
MUSICAL	YEAR	WORK	PUBLIC
BEST	SPENDING	PARENTS	TEACHER
ACTOR	NEW	SAYS	BENNETT
FIRST	STATE	FAMILY	MANIGAT
YORK	PLAN	WELFARE	NAMPHY
OPERA	MONEY	MEN	STATE
THEATER	PROGRAMS	PERCENT	PRESIDENT
ACTRESS	GOVERNMENT	CARE	ELEMENTARY
LOVE	CONGRESS	LIFE	HAITI

The William Randolph Hearst Foundation will give \$1.25 million to Lincoln Center, Metropolitan Opera Co., New York Philharmonic and Juilliard School. “Our board felt that we had a real opportunity to make a mark on the future of the performing arts with these grants an act every bit as important as our traditional areas of support in health, medical research, education and the social services,” Hearst Foundation President Randolph A. Hearst said Monday in announcing the grants. Lincoln Center’s share will be \$200,000 for its new building, which will house young artists and provide new public facilities. The Metropolitan Opera Co. and New York Philharmonic will receive \$400,000 each. The Juilliard School, where music and the performing arts are taught, will get \$250,000. The Hearst Foundation, a leading supporter of the Lincoln Center Consolidated Corporate Fund, will make its usual annual \$100,000 donation, too.

Generative Model for pLSA

- Describe how a document d is generated probabilistically

- For each position in d , $n = 1, \dots, N_d$

- Generate the topic for the position as $z_n | d \sim \text{Categorical}(\boldsymbol{\theta}_d)$, i. e., $p(z_n = k | d) = \theta_{dk}$

(Note, 1 trial multinomial)

- Generate the word for the position as

$$w_n | z_n \sim \text{Categorical}(\boldsymbol{\beta}_{z_n}), \text{ i. e., } p(w_n = w | z_n) = \beta_{z_n w}$$

Graphical Model

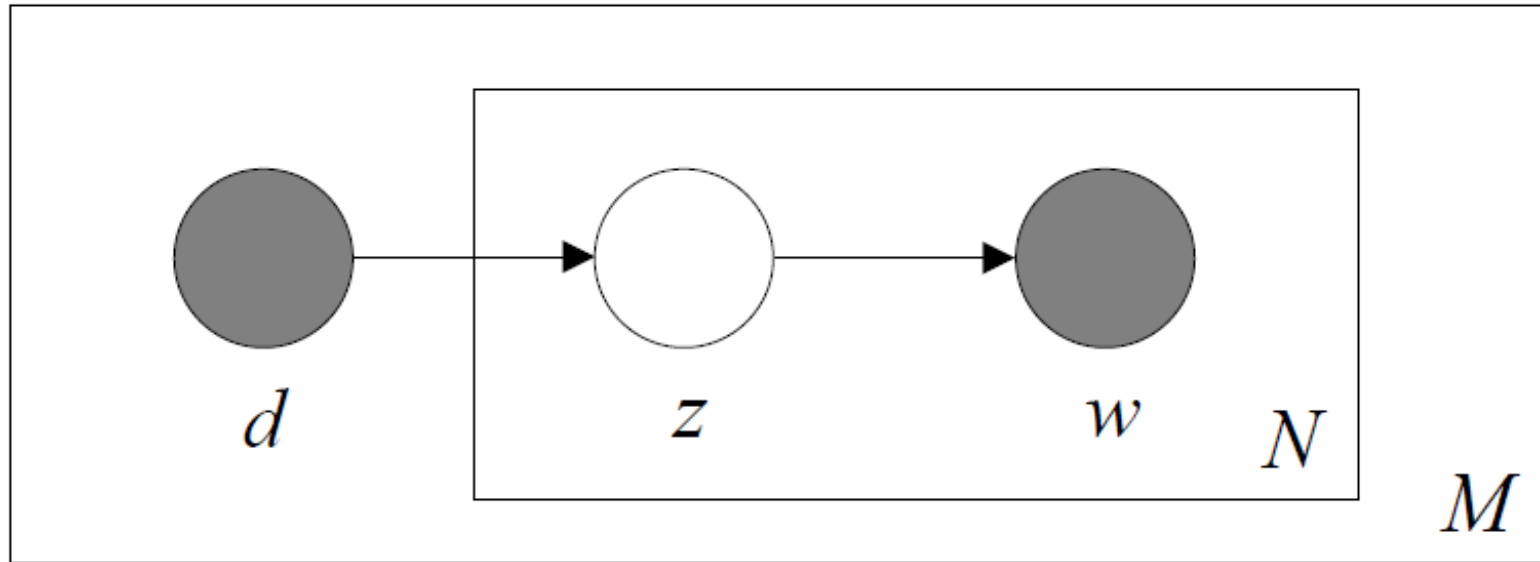

Note: Sometimes, people add parameters such as θ and β into the graphical model

The Likelihood Function for a Corpus

- Probability of a word w

$$\begin{aligned} p(w|d, \theta, \beta) &= \sum_k p(w, z = k|d, \theta, \beta) \\ &= \sum_k p(w|z = k, d, \theta, \beta) p(z = k|d, \theta, \beta) = \sum_k \beta_{kw} \theta_{dk} \end{aligned}$$

- Likelihood of a corpus

$$\begin{aligned} &\prod_{d=1} P(w_1, \dots, w_{N_d}, d|\theta, \beta, \pi) \\ &= \prod_{d=1} P(d) \left\{ \prod_{n=1}^{N_d} \left(\sum_k P(z_n = k|d, \theta_d) P(w_n|\beta_k) \right) \right\} \\ &= \prod_{d=1} \pi_d \left\{ \prod_{n=1}^{N_d} \left(\sum_k \theta_{dk} \beta_{kw_n} \right) \right\} \end{aligned}$$

π_d is usually considered as uniform, i.e., $1/M$

Re-arrange the Likelihood Function

- Group the same word from different positions together

$$\max \log L = \sum_{dw} c(w, d) \log \sum_z \theta_{dz} \beta_{zw}$$

$$s. t. \sum_z \theta_{dz} = 1 \text{ and } \sum_w \beta_{zw} = 1$$

Optimization: EM Algorithm

- Repeat until converge
 - E-step: for each word in each document, calculate its conditional probability belonging to each topic
$$p(z|w, d) \propto p(w|z, d)p(z|d) = \beta_{zw}\theta_{dz} \text{ (i.e., } p(z|w, d) = \frac{\beta_{zw}\theta_{dz}}{\sum_{z'} \beta_{z'w}\theta_{dz'}})$$
 - M-step: given the conditional distribution, find the parameters that can maximize the expected complete log-likelihood

$$\beta_{zw} \propto \sum_d p(z|w, d)c(w, d) \text{ (i.e., } \beta_{zw} = \frac{\sum_d p(z|w, d)c(w, d)}{\sum_{w', d} p(z|w', d)c(w', d)})$$
$$\theta_{dz} \propto \sum_w p(z|w, d)c(w, d) \text{ (i.e., } \theta_{dz} = \frac{\sum_w p(z|w, d)c(w, d)}{N_d})$$

Example

- Two documents, two topics

- Vocabulary: {1: data, 2: mining, 3: frequent, 4: pattern, 5: web, 6: information, 7: retrieval}

- A

word (w)	word count in Document 1 ($c(w, d_1)$)	$p(z = 1 w, d_1)$
data	5	0.8
mining	4	0.8
frequent	3	0.6
pattern	2	0.8
web	2	0.5
information	1	0.2

word (w)	word count in Document 2 ($c(w, d_2)$)	$p(z = 1 w, d_2)$
information	5	0.2
retrieval	4	0.2
web	3	0.1
mining	3	0.5
frequent	2	0.6
data	2	0.5

Example (Continued)

- M-step

$$\beta_{11} = \frac{0.8 * 5 + 0.5 * 2}{11.8 + 5.8} = 5/17.6$$

$$\beta_{12} = \frac{0.8 * 4 + 0.5 * 3}{11.8 + 5.8} = 4.7/17.6$$

$$\beta_{13} = 3/17.6$$

$$\beta_{14} = 1.6/17.6$$

$$\beta_{15} = 1.3/17.6$$

$$\beta_{16} = 1.2/17.6$$

$$\beta_{17} = 0.8/17.6$$

$$\theta_{11} = \frac{11.8}{17}$$

$$\theta_{12} = \frac{5.2}{17}$$

Question

- For the same word in different positions in a document, do they have the same conditional probability $p(z|w, d)$?

Text Data: Topic Models

- Text Data and Topic Models
- Revisit of Multinomial Mixture Model
- Probabilistic Latent Semantic Analysis (pLSA)
- Latent Dirichlet Allocation (LDA) 
- Summary

Limitations of pLSA

- Not a proper generative model
 - θ_d is treated as a parameter
 - Cannot model new documents
- Solution:
 - Make it a proper generative model by adding priors to θ and β

Review of Conjugate Prior

- Model:
 - $p(x|\theta)$
- Prior:
 - $p(\theta|\alpha)$
- Posterior:
 - $p(\theta|x, \alpha) \propto p(\theta, x|\alpha) = p(x|\theta)p(\theta|\alpha)$
- Conjugate prior:
 - If $p(\theta|\alpha)$ and $p(\theta|x, \alpha)$ belong to the same distribution family (with different parameters), $p(\theta|\alpha)$ is called a conjugate prior for the likelihood function

Dirichlet Distribution

- Dirichlet distribution: $\theta \sim \text{Dirichlet}(\alpha)$

- *i. e.*, $p(\theta|\alpha) = \frac{\Gamma(\sum_k \alpha_k)}{\prod_k \Gamma(\alpha_k)} \prod_k \theta_k^{\alpha_k - 1}$, where $\alpha_k > 0$

- $\Gamma(\cdot)$ is gamma function: $\Gamma(z) = \int_0^\infty e^{-t} t^{z-1} dt$
 - $\Gamma(z + 1) = z\Gamma(z)$

- $E(\theta_k) = \frac{\alpha_k}{\sum_{k'} \alpha_{k'}}$, $Var(\theta_k) = \frac{\alpha_k(\alpha_0 - \alpha_k)}{\alpha_0^2(\alpha_0 + 1)}$, where $\alpha_0 =$

$\sum_k \alpha_k$

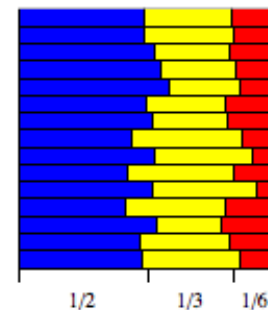
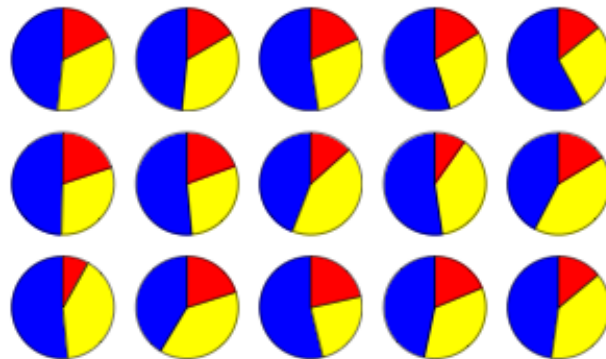

Example: $\theta \sim \text{Dirichlet}(\alpha)$, where $\alpha/\alpha_0 = (\frac{1}{2}, \frac{1}{3}, \frac{1}{6})$

More Examples

Dirichlet(1,1,1)

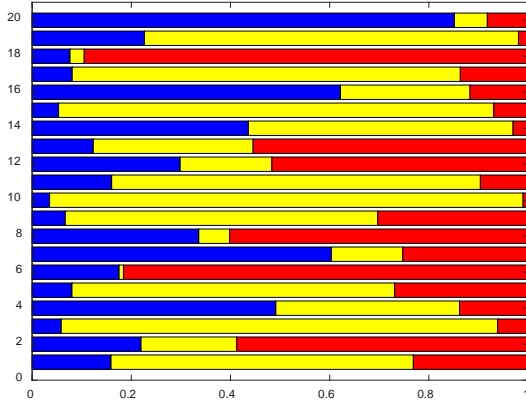

Dirichlet(2,2,2)

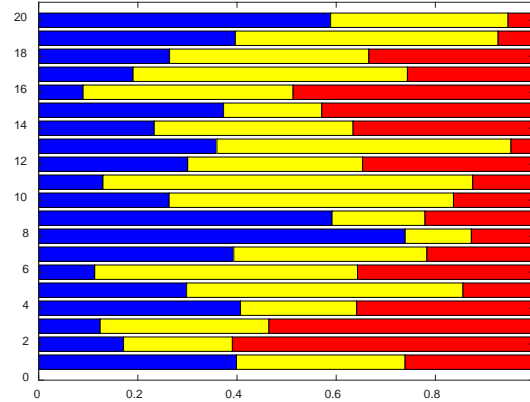

Dirichlet(10,10,10)

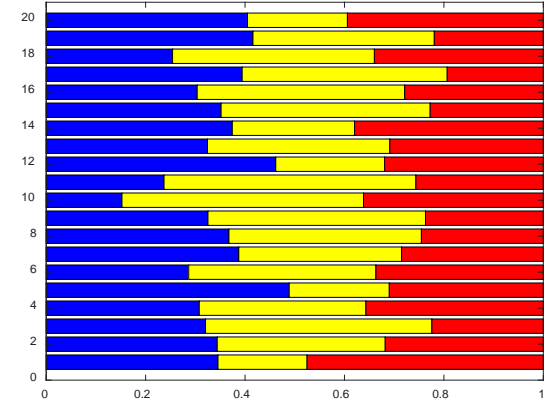

Dirichlet(2,2,10)

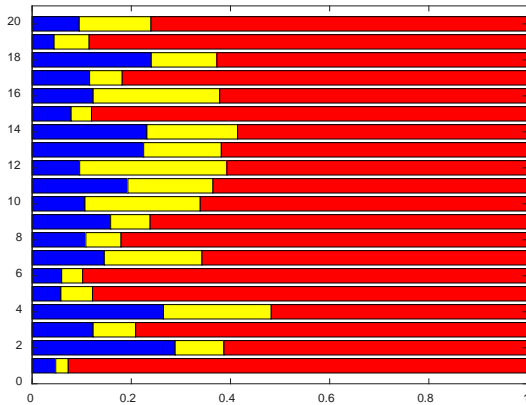

Dirichlet(2,10,2)

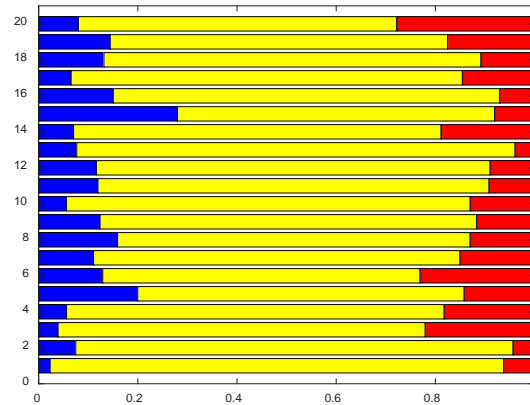

Dirichlet(0.1,0.1,0.1)

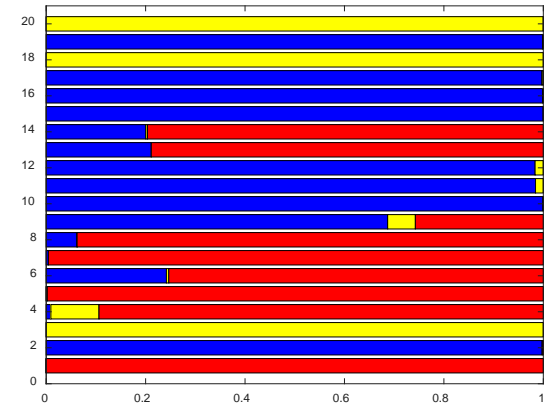

Simplex View

- $\alpha = (2,3,4)$

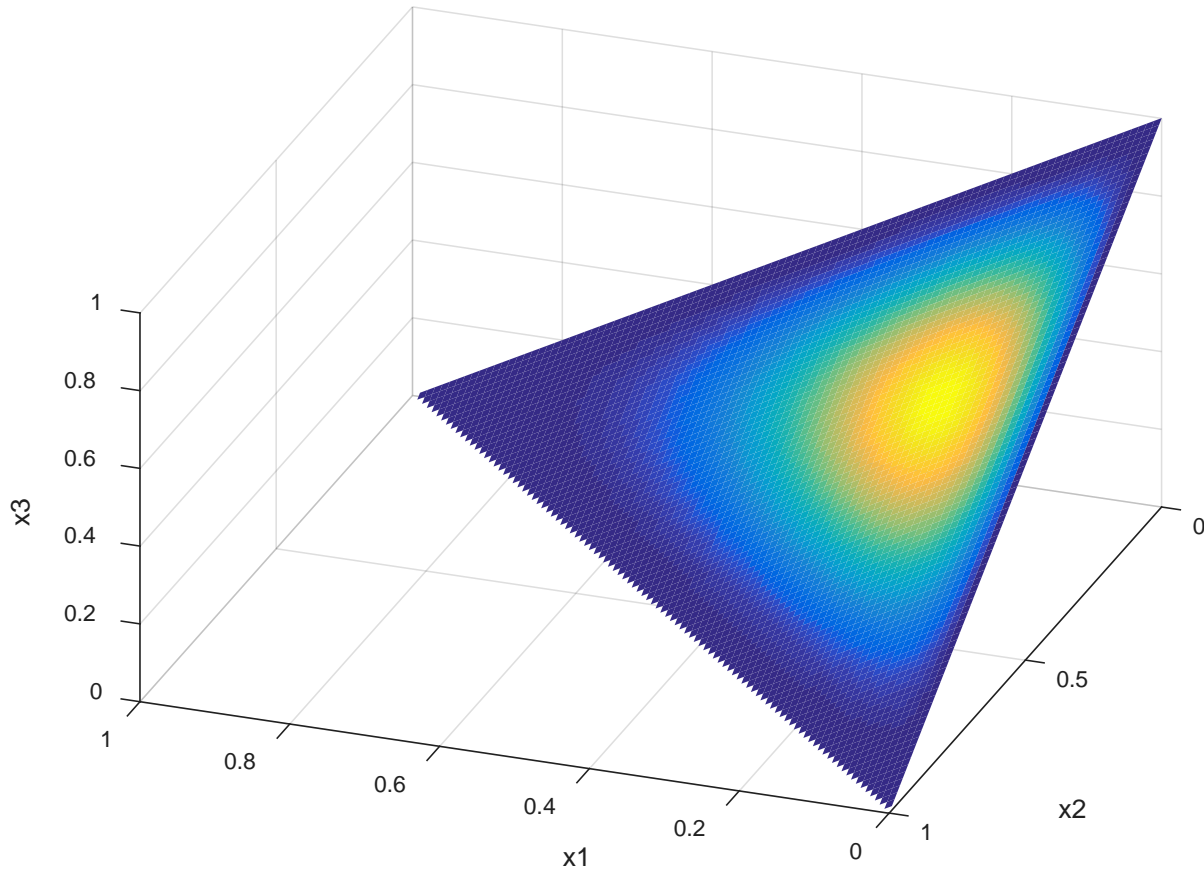

More Examples in the Simplex View

Dirichlet(1,1,1)

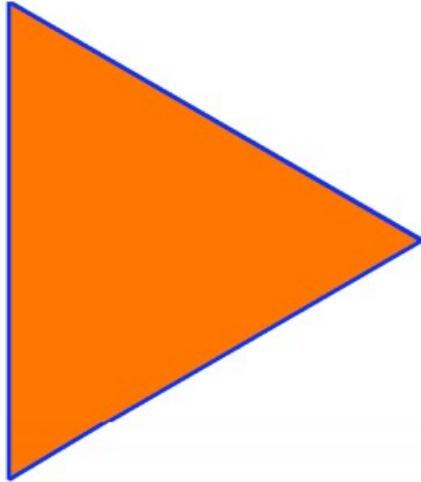

Dirichlet(2,2,2)

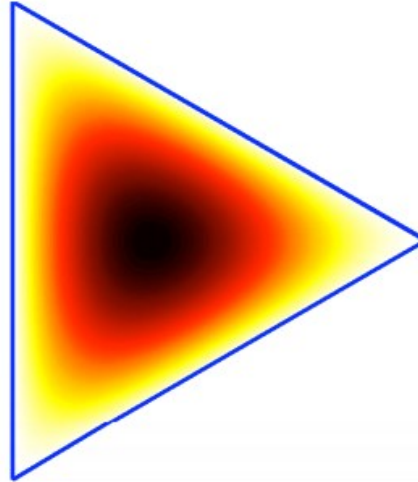

Dirichlet(10,10,10)

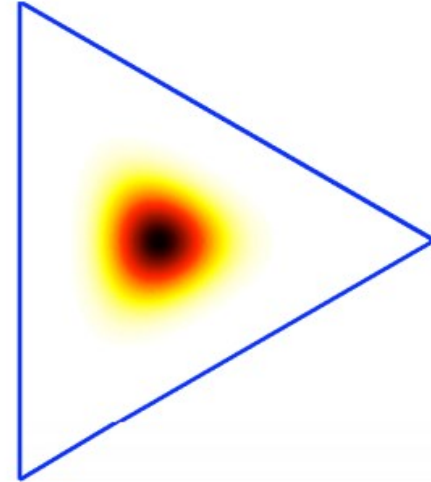

Dirichlet(2,2,10)

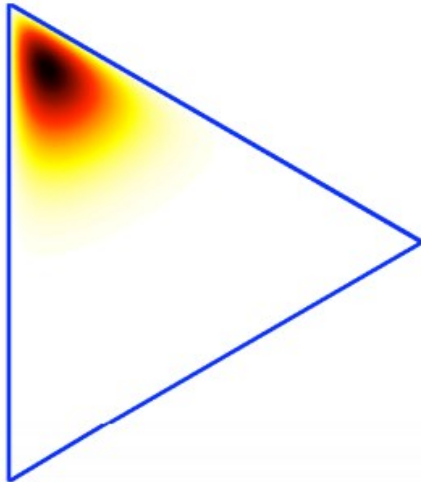

Dirichlet(2,10,2)

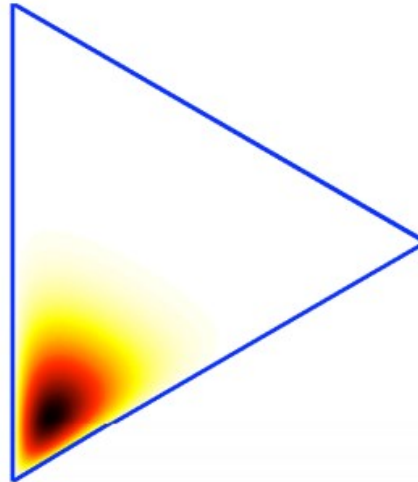

Dirichlet(0.8,0.8,0.8)

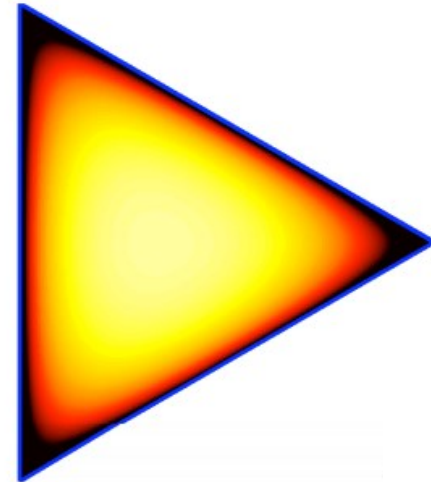

Dirichlet-Multinomial/Categorical Conjugate

- The model (independent categorical distribution)
 - $p(z_1, \dots, z_n | \boldsymbol{\theta}) \propto \prod_k \theta_k^{c_k}$
 - where c_k is the number of z that takes value of k
- Posterior
 - $p(\boldsymbol{\theta} | \boldsymbol{\alpha}, z_1, z_2, \dots, z_n) \propto p(z_1, \dots, z_n | \boldsymbol{\theta}) p(\boldsymbol{\theta} | \boldsymbol{\alpha})$
 $\propto \prod_k \theta_k^{\alpha_k + c_k - 1}$
 - Dirichlet distribution again!

The Graphical Model of LDA

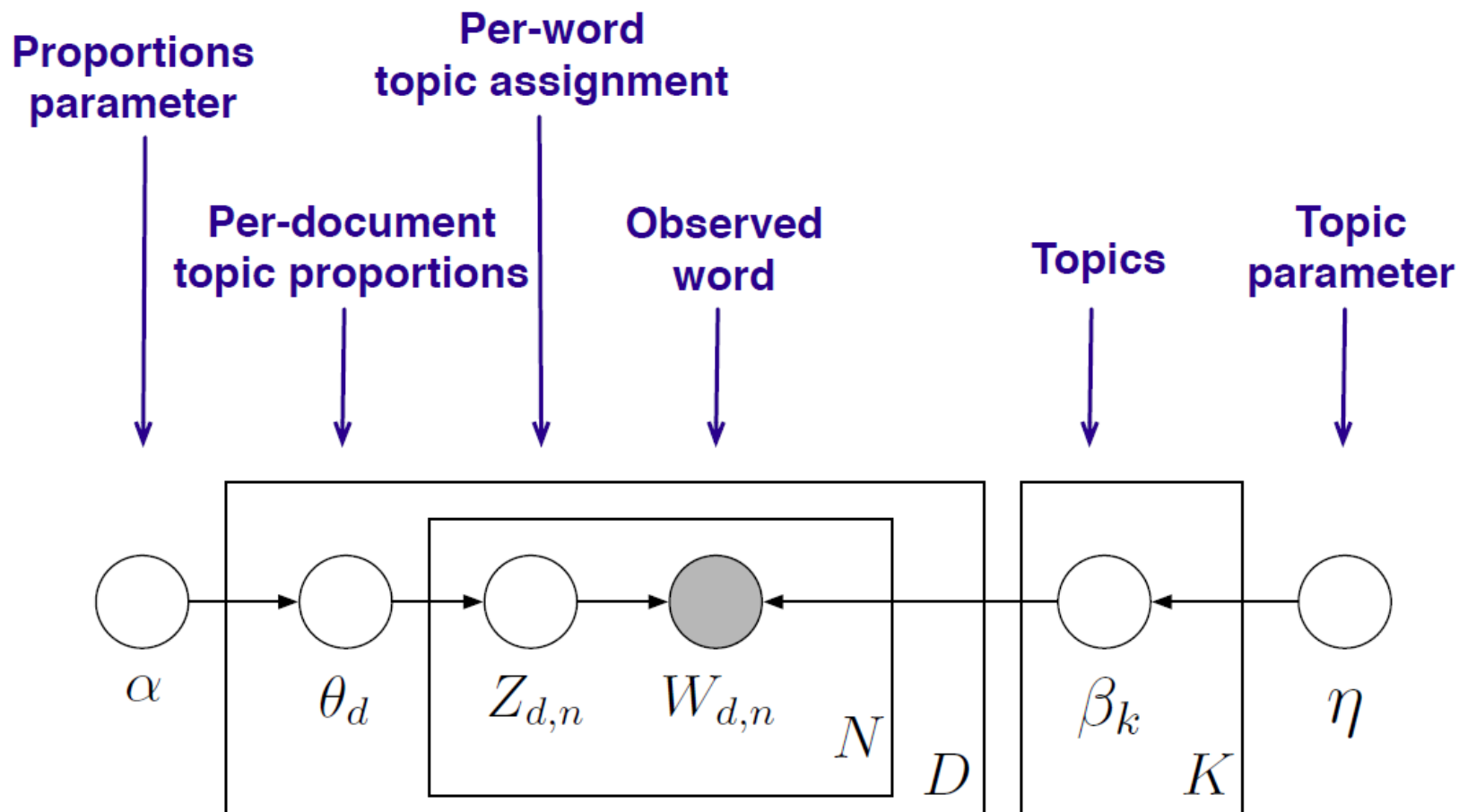

$\theta_d \sim \text{Dirichlet}(\alpha)$: address topic distribution for unseen documents
 $\beta_k \sim \text{Dirichlet}(\eta)$: smoothing over words

Joint Distribution for LDA

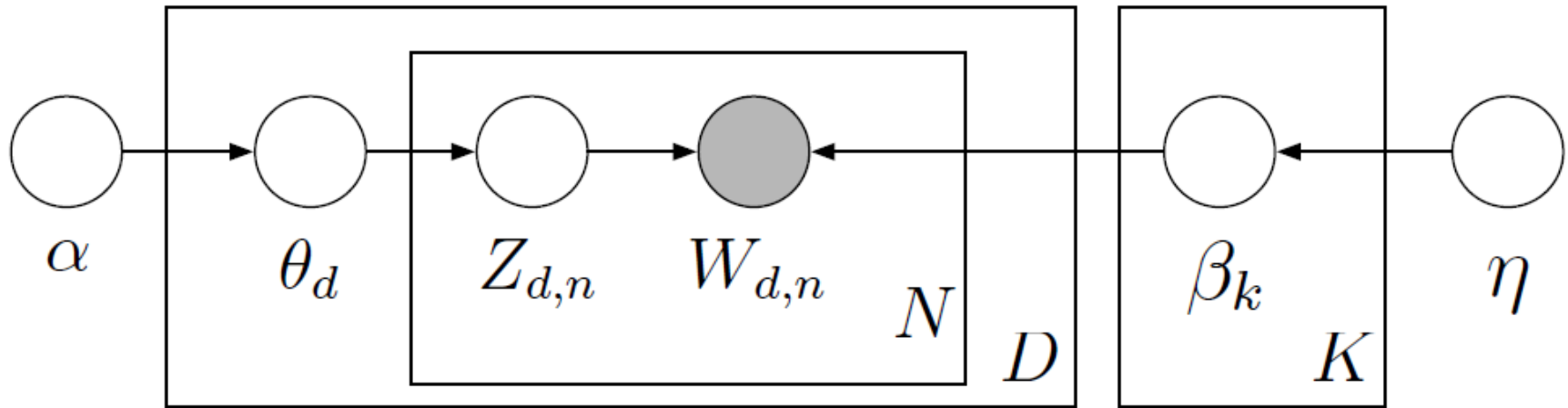

- Joint distribution of latent variables and documents is:

$$p(\boldsymbol{\beta}_{1:K}, \mathbf{z}_{1:D}, \boldsymbol{\theta}_{1:D}, \mathbf{w}_{1:D} | \alpha, \eta) =$$

$$\prod_{i=1}^K p(\beta_i | \eta) \prod_{d=1}^D p(\theta_d | \alpha) \left(\prod_{n=1}^N p(z_{d,n} | \theta_d) p(w_{d,n} | \beta_{1:K}, z_{d,n}) \right)$$

Posterior Inference

- Posterior of the latent variables

$$p(\beta, \theta, \mathbf{z} | \mathbf{w})$$
$$= \frac{p(\beta, \theta, \mathbf{z}, \mathbf{w})}{\int_{\beta} \int_{\theta} \sum_{\mathbf{z}} p(\beta, \theta, \mathbf{z}, \mathbf{w})}$$

- Solutions

marginal $p(\mathbf{w})$ is intractable!

- Gibbs sampling [Griffiths et al., Finding Scientific Topics, PNAS (2004)]
- Variational inference [Blei et al., Latent Dirichlet Allocation, JLMR (2003)]

Parameter Estimation

- Estimate α and η based on training dataset
- Solution
 - Variational EM algorithm

Generative Process of A Simplified LDA

- Assuming no smoothing part
 - I.e., Given α, β
- For each document \mathbf{w}_d in a corpus
 - Not essential, and can be ignored*
 - 1. Choose document length $N_d \sim \text{Poisson}(\xi)$
 - 2. Choose $\theta_d \sim \text{Dir}(\alpha)$
 - 3. For each word in the document $w_{d,n}$:
 - a) Choose a topic $z_{d,n} \sim \text{Categorical}(\theta_d)$
 - b) Choose a word $w_{d,n}$ from $p(w_{d,n} | z_{d,n}, \beta)$, which is a categorical distribution conditional on topic $z_{d,n}$

Graphical Model and Joint Distribution

- Graphical model

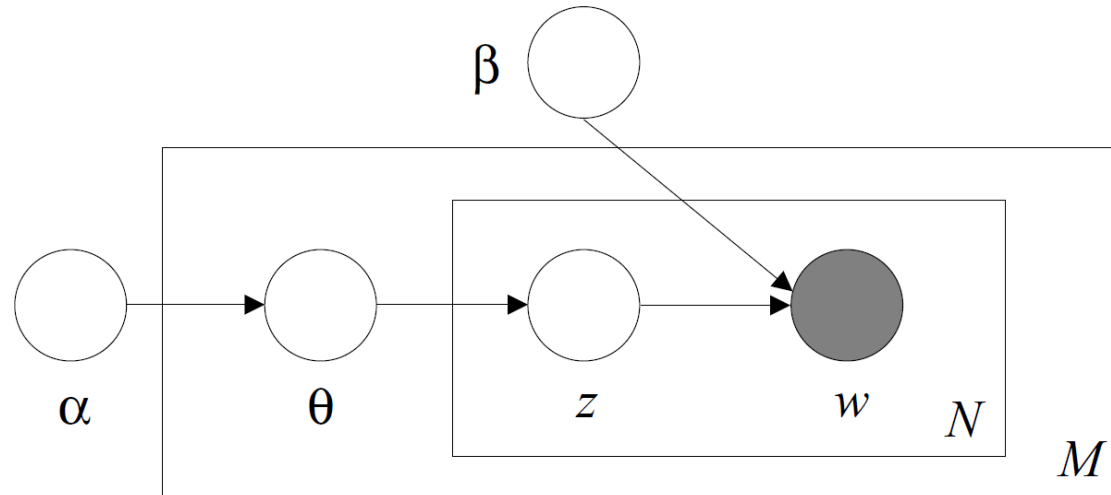

- Joint distribution for a single document

- $$p(\theta, \mathbf{z}, \mathbf{w} | \alpha, \beta) = p(\theta | \alpha) \prod_{n=1}^N p(z_n | \theta) p(w_n | z_n, \beta)$$

Marginal Distribution and Likelihood

- Marginal distribution of a document

- $$p(\mathbf{w} | \alpha, \beta) = \int p(\theta | \alpha) \left(\prod_{n=1}^N \sum_{z_n} p(z_n | \theta) p(w_n | z_n, \beta) \right) d\theta$$

- Question: Why we can push summation of z inside?

- Likelihood of a corpus

$$p(D | \alpha, \beta) = \prod_{d=1}^M \int p(\theta_d | \alpha) \left(\prod_{n=1}^{N_d} \sum_{z_{dn}} p(z_{dn} | \theta_d) p(w_{dn} | z_{dn}, \beta) \right) d\theta_d$$

Inference

- Compute the posterior distribution of the hidden variables given a document

Joint distribution computation: Easy

$$p(\theta, \mathbf{z} | \mathbf{w}, \alpha, \beta) = \frac{p(\theta, \mathbf{z}, \mathbf{w} | \alpha, \beta)}{p(\mathbf{w} | \alpha, \beta)}$$

Marginal distribution computation: intractable

Variational Inference

- Find a simple distribution $q(\theta, z|\gamma, \phi)$ to approximate $p(\theta, z|w, \alpha, \beta)$
 - By dropping edges among θ, z , and w , which causes the coupling between θ and β

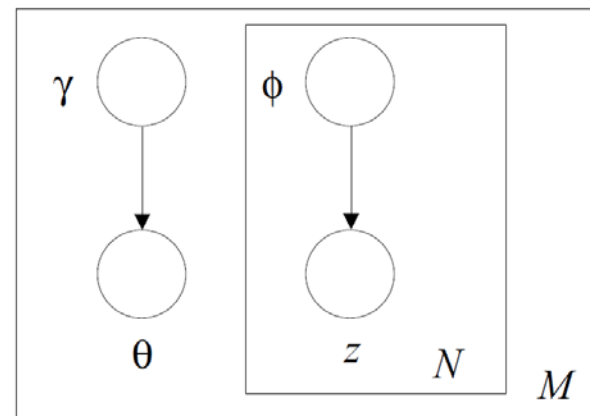
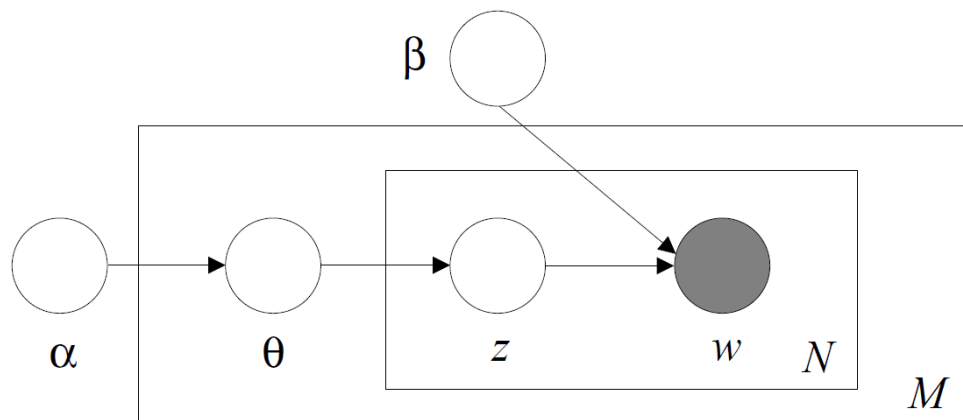

- $q(\theta, z|\gamma, \phi) = q(\theta|\gamma) \prod_{n=1}^N q(z_n|\phi_n)$
 - γ, ϕ are **free** variational parameters

The Criterion to Choose q

- KL divergence between two distributions

$$D_{KL}(P||Q) = \sum_i P(i) \log \frac{P(i)}{Q(i)}$$

$$D_{KL}(P||Q) = \int P(x) \log \frac{P(x)}{Q(x)} dx$$

- Minimize the KL divergence between

$q(\theta, z|\gamma, \phi)$ and $p(\theta, z|w, \alpha, \beta)$

- $D(q(\theta, z|\gamma, \phi)||p(\theta, z|w, \alpha, \beta)) =$
 $E_q(\log q(\theta, z|\gamma, \phi) - \log p(\theta, z|w, \alpha, \beta))$

$$(\gamma^*, \phi^*) = \arg \min_{(\gamma, \phi)} D(q(\theta, \mathbf{z}|\gamma, \phi) || p(\theta, \mathbf{z}|\mathbf{w}, \alpha, \beta))$$

ELBO: Evidence Lower Bound

- Instead of minimizing KL divergence direction, maximize ELBO
 - Can be obtained by applying Jensen's inequality:
 $f(E(X)) \geq E(f(X))$, if f is concave

$$\begin{aligned}\log p(\mathbf{w} | \alpha, \beta) &= \log \int \sum_{\mathbf{z}} p(\theta, \mathbf{z}, \mathbf{w} | \alpha, \beta) d\theta \\ &= \log \int \sum_{\mathbf{z}} \frac{p(\theta, \mathbf{z}, \mathbf{w} | \alpha, \beta) q(\theta, \mathbf{z})}{q(\theta, \mathbf{z})} d\theta \\ &\geq \int \sum_{\mathbf{z}} q(\theta, \mathbf{z}) \log p(\theta, \mathbf{z}, \mathbf{w} | \alpha, \beta) d\theta - \int \sum_{\mathbf{z}} q(\theta, \mathbf{z}) \log q(\theta, \mathbf{z}) d\theta \\ &= \underbrace{E_q[\log p(\theta, \mathbf{z}, \mathbf{w} | \alpha, \beta)] - E_q[\log q(\theta, \mathbf{z})]}_{\text{ELBO, denoted as } L(\gamma, \phi; \alpha, \beta)}.\end{aligned}$$

ELBO, denoted as $L(\gamma, \phi; \alpha, \beta)$

Why?

- ELBO + KL-divergence = Constant

$$\log p(\mathbf{w} | \alpha, \beta) = L(\gamma, \phi; \alpha, \beta) + D(q(\theta, \mathbf{z} | \gamma, \phi) || p(\theta, \mathbf{z} | \mathbf{w}, \alpha, \beta))$$

ELBO Optimization

- Coordinate ascent
 - Iteratively optimizing each variational parameter holding the others fixed

(1) initialize $\phi_{ni}^0 := 1/k$ for all i and n

(2) initialize $\gamma_i := \alpha_i + N/k$ for all i

(3) **repeat**

(4) **for** $n = 1$ **to** N

$\Psi(\mathbf{x})$: first derivative of $\log\Gamma(\mathbf{x})$

(5) **for** $i = 1$ **to** k

(6) $\phi_{ni}^{t+1} := \beta_{i w_n} \exp(\Psi(\gamma_i^t))$

(7) normalize ϕ_n^{t+1} to sum to 1.

(8) $\gamma^{t+1} := \alpha + \sum_{n=1}^N \phi_n^{t+1}$

(9) **until** convergence

Parameter Estimation

- Objective: Find α and β that can maximize log-likelihood function with constraints

- $$\ell(\alpha, \beta) = \sum_{d=1}^M \log p(\mathbf{w}_d | \alpha, \beta)$$

- Solution: Variational EM algorithm

- E-step: find γ_d^* and ϕ_d^* for each document by maximizing the lower bound of the likelihood function (Done!)
- M-step: maximizing the lower bound obtained from E-step with respect to α and β

Text Data: Topic Models

- Text Data and Topic Models
- Revisit of Multinomial Mixture Model
- Probabilistic Latent Semantic Analysis (pLSA)
- Latent Dirichlet Allocation (LDA)
- Summary 

Summary

- Basic Concepts
 - Word/term, document, corpus, topic
 - How to represent a document
- Mixture of unigrams
- pLSA
 - Generative model
 - Likelihood function
 - EM algorithm
- LDA
 - Dirichlet-multinomial conjugate
 - Posterior inference

References

- T. Hofmann. Probabilistic latent semantic indexing. Proceedings of the Twenty-Second Annual International SIGIR Conference, 1999.
- David Blei, lecture notes on variational inference: <https://www.cs.princeton.edu/courses/archive/fall11/cos597C/lectures/variational-inference-i.pdf>
- David Blei, Andrew Ng, Michael Jordan, “Latent Dirichlet Allocation”, JMLR, 2003. <http://www.jmlr.org/papers/volume3/blei03a/blei03a.pdf>
- Thomas L. Griffiths and Mark Steyvers, “Finding Scientific Topics”, PNAS, 2004. https://www.pnas.org/content/101/suppl_1/5228